

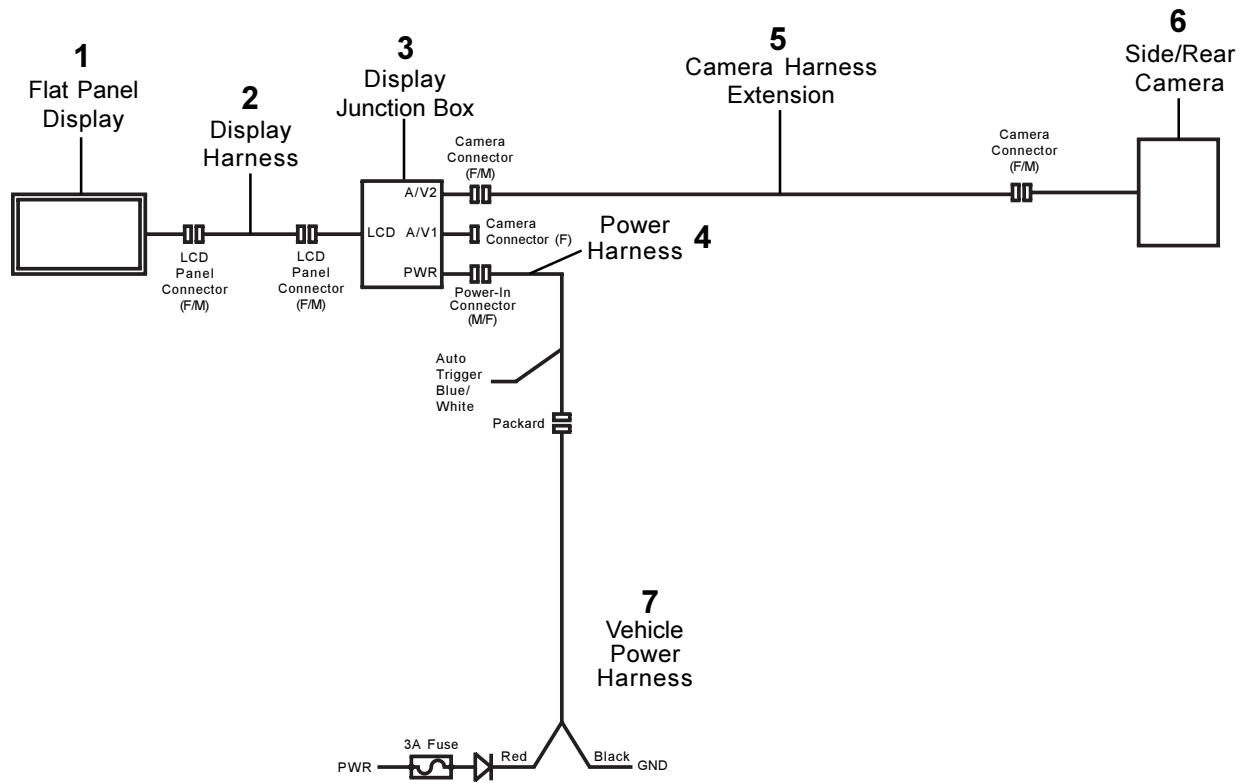



**Kit Service Piece No.
801502**



<p>1</p>  <p>Flat Panel Display (5011944)</p>	<p>2</p>  <p>Display Harness (5011945)</p>	<p>3</p>  <p>Display Junction Box (5011943)</p>	<p>4</p>  <p>Power Harness (5011942)</p>	<p>5</p>  <p>Camera Harness Extension (5011953)</p>	<p>6</p>  <p>Side/Rear Camera (5011948)</p>	<p>7</p>  <p>Vehicle Power Harness (5012050)</p>
---	--	---	---	---	---	--

Video Camera and Flat Panel Display Schematic SE1029

Vehicle Power Harness (5012050)

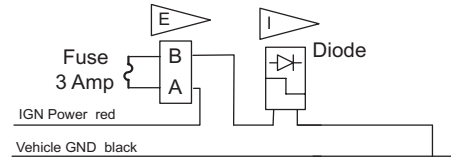

Power Harness (5011942)

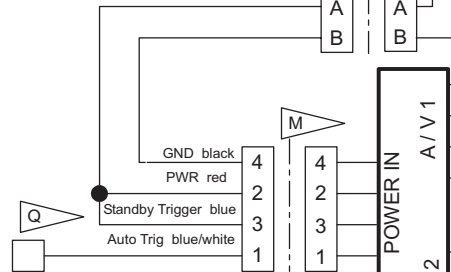

Display Junction Box (5011943)
LCD PANEL
POWER IN
A / V 1
A / V 2

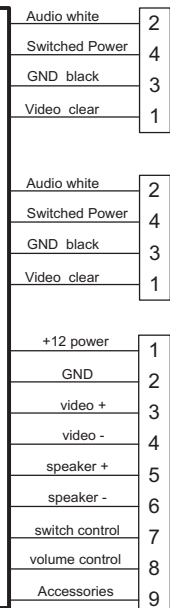

Camera Harness
Ext. (5011953)

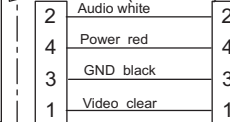

Side / Rear
Camera (5011948)

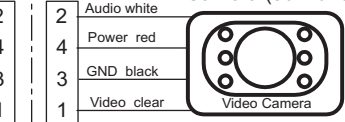

Display Harness (5011945)

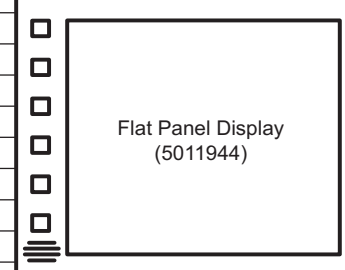
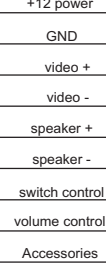

- A** 12 Pin Sealed Deutsch Connector
- B** 3 Pin Unsealed Packard Metri-Pack Connector
- C** 4 Pin Unsealed Packard Metri-Pack Connector
- D** 2 Pin Unsealed Packard Metri-Pack Connector
- E** Packard Sealed Fuse Connector
- F** 1/4 inch ring terminal
- G** SAE J928 Bullet Connector
- H** 8 Pin Unsealed Packard Metri-Pack Connector
- I** Integral diode connector
- J** 6 Pin Sealed Packard Metri-Pack Connector
- K** 2 Pin Sealed Packard Metri-Pack Connector
- L** 4 Pin Sealed Proprietary Power Connector
- M** 4 Pin Sealed Proprietary Video Connector
- N** 9 Pin Sealed Proprietary FPD Connector
- O** 8 Pin Unsealed Molex Connector
- P** 5 Pin Unsealed Molex Connector
- Q** 1 Pin Unsealed Packard Metri-Pack Connector
- R** 4 Pin Unsealed Packard Metri-Pack Connector