

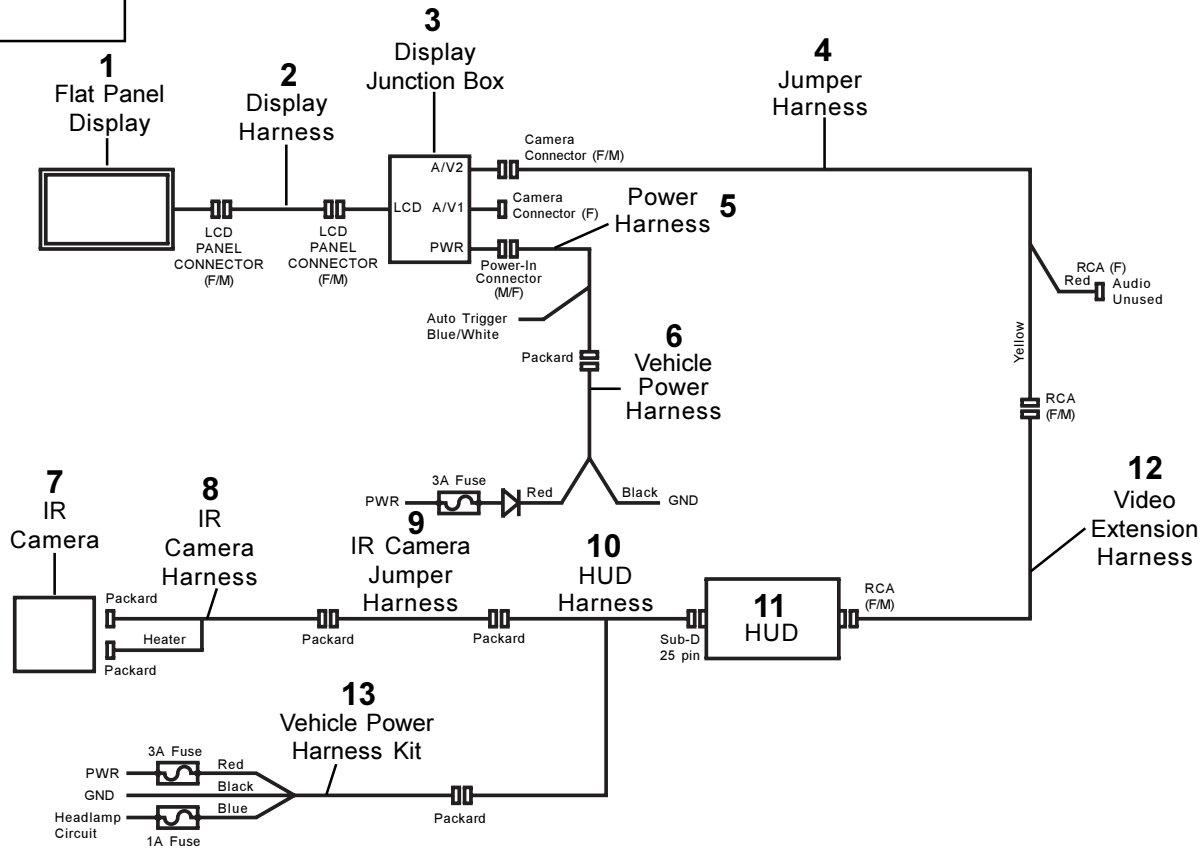













**Kit Service Piece No.
801501**



| | | | | | | |
|---|---|--|--|---|---|---|
| <p>1</p>  <p>Flat Panel Display (5011944)</p> | <p>2</p>  <p>Display Harness (5011945)</p> | <p>3</p>  <p>Display Junction Box (5011943)</p> | <p>4</p>  <p>Jumper Harness (5012039)</p> | <p>5</p>  <p>Power Harness (5011942)</p> | <p>6</p>  <p>Vehicle Power Harness (5012050)</p> | <p>7</p>  <p>XVision® IR Camera (5008214)</p> |
| <p>8</p>  <p>IR Camera Harness (5010246)</p> | <p>9</p>  <p>IR Camera Jumper Harness (5010441)</p> | <p>10</p>  <p>HUD Harness (5010259 or 5010263)</p> | <p>11</p>  <p>HUD Display (5010210)</p> | <p>12</p>  <p>Video Extension Harness (5012052)</p> | <p>13</p>  <p>Vehicle Power Harness Kit (5011715)</p> | |

IR Camera, HUD and Flat Panel Display Schematic SE1026

