



# Service Data

SD-01-3121

## BENDIX® 360CC SINGLE CYLINDER COMPRESSOR FOR INTERNATIONAL MAXXFORCE™ 11 AND 13 BIG BORE ENGINES

### DESCRIPTION

The function of the air compressor is to provide and maintain air under pressure to operate devices in air brake systems. The Bendix® 360cc compressor is a single-cylinder compressor with a rated displacement of 15.8 cubic feet per minute at 1250 RPM. The compressor consists of an integral water-cooled cylinder head assembly and water-cooled crankcase.

The cylinder head assembly is made up of an aluminum cylinder head, an aluminum cooling plate, and a steel valve plate assembly with two sealing gaskets. The cylinder head contains air and water ports. The cooling plate, situated between the head and valve plate, assists in cooling the head assembly. The valve plate assembly, consisting of brazed steel plates, has separate valve openings and passages to allow air and coolant to flow in and out of the compressor. See Figure 1 for an external view, and Figure 3 for an exploded view.

The compressor is equipped with a safety valve in the cylinder head safety valve port, directly connected to the discharge port. The safety valve protects the compressor head in the event of excessively high discharge line pressure, for example, in the event of blockage downstream of the compressor. Excessive air pressure causes the safety valve to unseat, releases air pressure and gives an audible alert to the operator.

The compressor is cooled by air flow, as well as by engine coolant. The engine coolant first enters the crankcase water jacket to cool the cylinder bore, then passes through passages in the valve plate assembly, cooling plate, and cylinder head and then out of a port at the top of the compressor, back to the engine.

A nameplate is attached to a flat cast face on the side of the crankcase. It is stamped with information identifying the compressor designation, customer piece number, compressor assembly part number and serial number. See Figure 2.

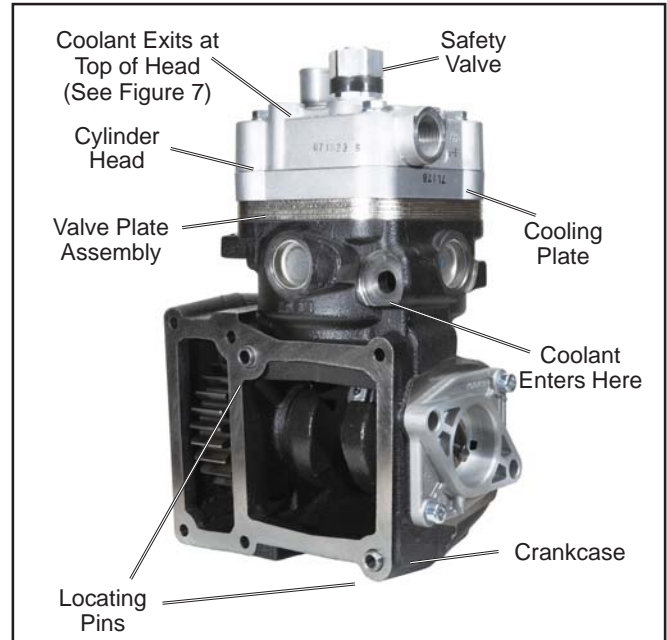

FIGURE 1 - BENDIX® 360cc SINGLE CYLINDER COMPRESSOR

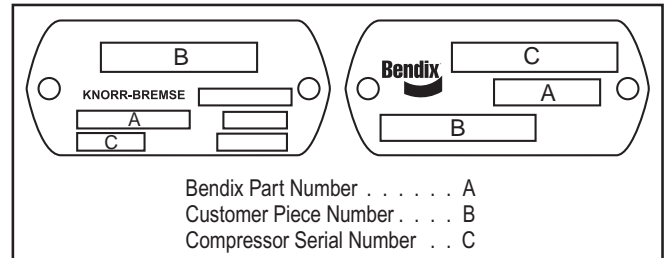
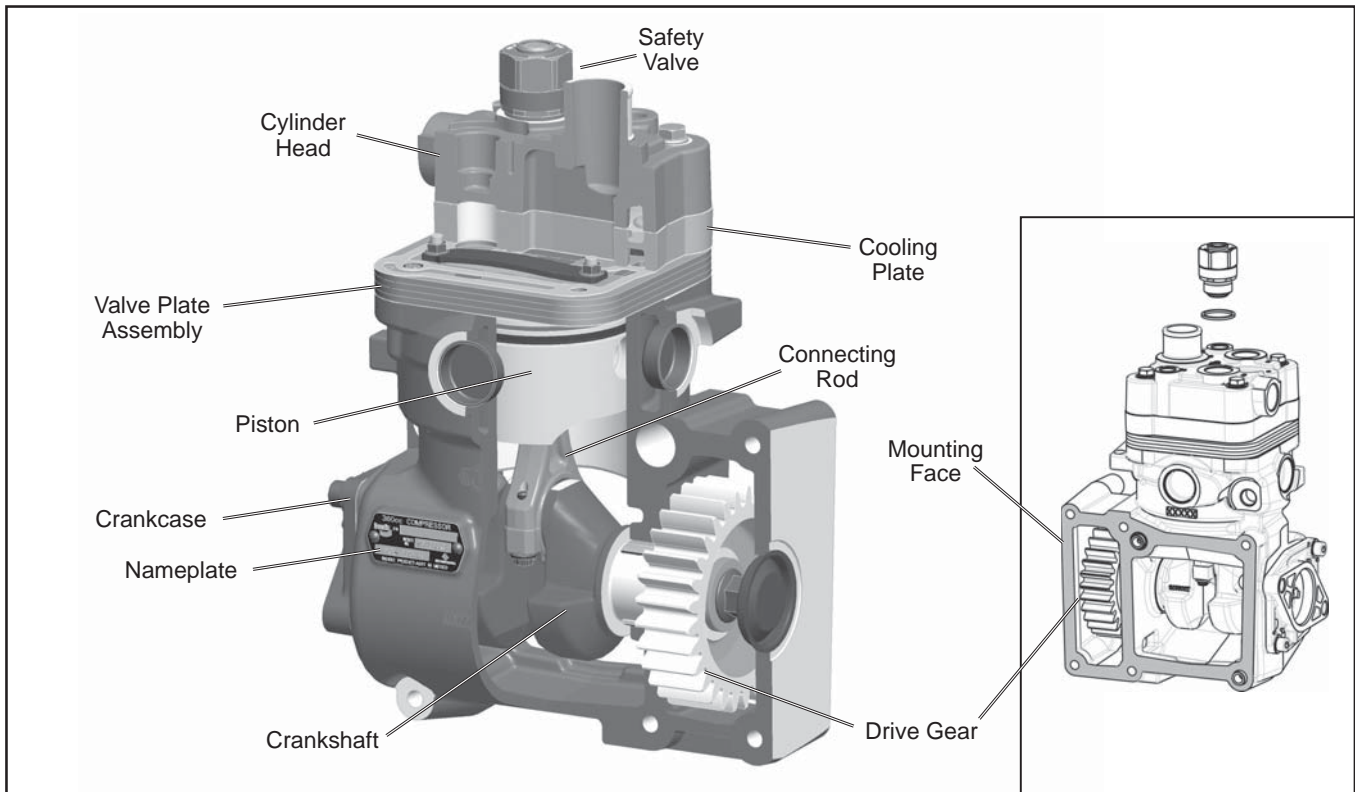

FIGURE 2 - NAMEPLATES (TWO STYLES)

### GENERAL INFORMATION

This Bendix® 360cc compressor is a “discharge line unloader” (DLU)-style compressor, meaning that the compressor pumps continuously, unlike some compressor designs which use an “unloader” mechanism in the compressor head to switch from a pumping mode to a non-pumping mode. Instead, the control of air delivery to the vehicle’s air system is managed by using a separate discharge line unloader valve mounted in parallel with a turbo cut-off style of air dryer (see Figure 6).



**FIGURE 3 - BENDIX® 360cc SINGLE CYLINDER COMPRESSOR (CUT-AWAY VIEW)**

The crankcase has an open side with a machined face and locating pins. This open face is bolted directly to the side of the engine block, see Figure 3. The compressor gear engages the engine drive gear. In addition, the crankcase houses the piston assembly, connecting rod, crankshaft and related bearings. An o-ring is located in the countersunk hole on the crankcase deck to seal the coolant passage between the crankcase and valve plate.

**OPERATION**

The compressor is driven by the vehicle's engine and functions continuously while the engine is in operation. Actual compression of air is controlled by a downstream component, such as a discharge line unloader valve or an air dryer without turbo cut-off valve, operating in conjunction with a governor.

**AIR INTAKE (LOADED)**

Just as the piston begins the down stroke, (a position known as top dead center, or TDC), the vacuum created in the cylinder bore above the piston causes the inlet reed valve to flex open. Atmospheric air flows through the open inlet valve and fills the cylinder bore above the piston. See Figure 4.

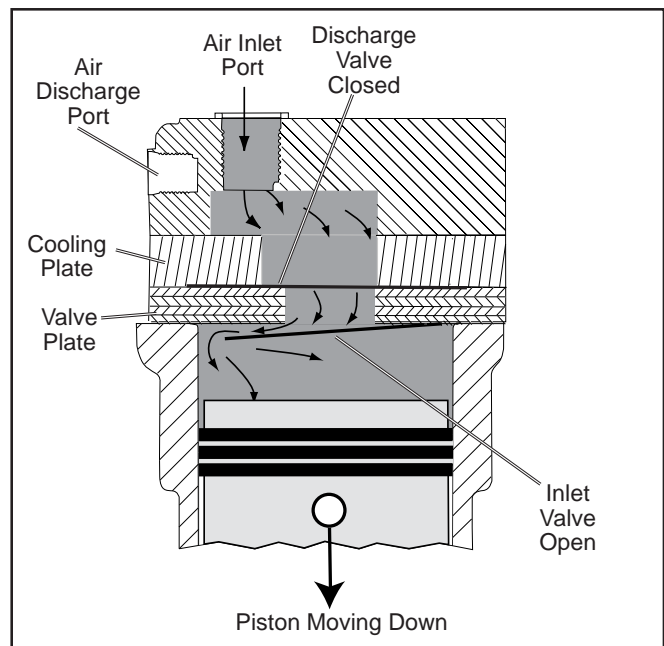

**FIGURE 4 - OPERATION - INTAKE**

**AIR COMPRESSION (LOADED)**

When the piston reaches the bottom of the stroke, (a position known as bottom dead center, or BDC), the inlet reed valve closes. Air above the piston is trapped by the closed inlet reed valve and is compressed as the piston moves upwards. When air in the cylinder bore reaches a pressure greater than that of the system pressure, the discharge reed valves open and allow air to flow into the discharge line and air brake system. See Figure 5.

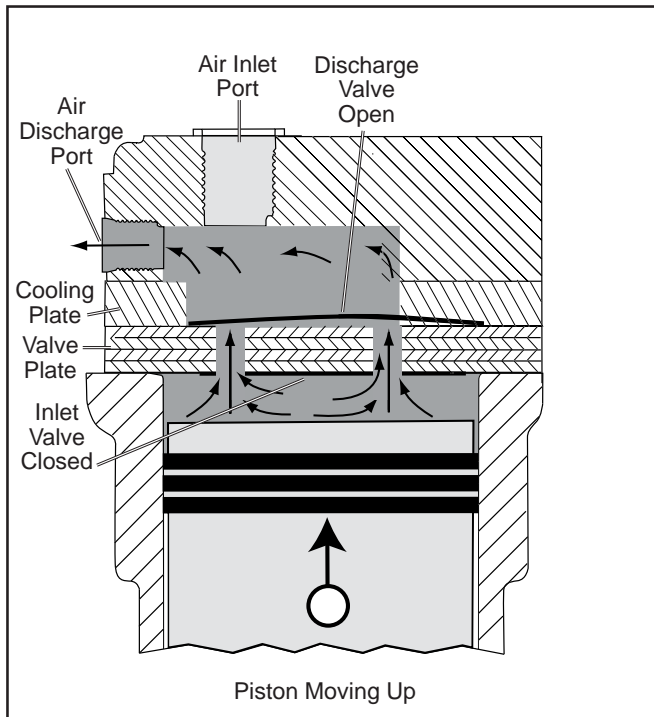

**FIGURE 5 - OPERATION - COMPRESSION**  
**NON-COMPRESSION OF AIR (UNLOADED)**  
**COMPRESSOR AND AIR DRYER SYSTEM**  
**(REFER TO FIGURE 6)**

Air delivery to the vehicle's air system is controlled by the governor and the air dryer, or with a separate discharge line unloader valve. The governor is plumbed to the component (e.g. air dryer or DLU valve) in order to control when the air is delivered to the vehicle's air system.

When air pressure in the supply reservoir reaches the cutout setting of the governor, the governor delivers system air to the discharge line unloader-style (DLU) air dryer's control port. This allows the discharge air from the compressor to flow out the exhaust port of the air dryer.

Note: The Bendix® 360cc compressor is a discharge line unloader-style unit. This means that the compressor functions in a continuous pumping mode regardless whether the brake system requires air. It requires a downstream device (e.g. turbo cut-off style air dryer and discharge line unloader valve) to unload the system when the air system has sufficient stored compressed air.

**LUBRICATION**

The vehicle's engine provides a continuous supply of oil to the compressor. Oil is routed from the engine to the compressor's oil inlet. Note: There is no external oil supply line; the oil delivery is located at the engine to compressor mounting face. This pressurized oil flows to the precision front sleeve main bearing, and via an oil passage in the crankshaft routes pressurized oil to the connecting rod bearings and the rear journal associated with the end cover. Spray lubrication of the cylinder bore and connecting rod wrist pin bushing is obtained as oil is forced out around the crankshaft journals by engine oil pressure. Oil then falls to the bottom of the compressor crankcase and is returned to the engine through the opening at the compressor mounting flange.

**COOLING**

The Bendix® 360cc Single Cylinder Compressor is cooled by air flowing through the engine compartment as it passes the compressor's cast-in cooling fins and by the flow of engine coolant through the cylinder head assembly and the water jacket around the cylinder bore of the crankcase. Coolant supplied by the engine cooling system passes through connecting lines into the cylinder head, cooling plate, valve plate assembly, into the crankcase water jacket and returns through the same components, out of the coolant outlet port of the cylinder head and returns to the engine. Figure 7 illustrates the approved coolant flow connections. Proper cooling is important in minimizing discharge air temperatures – see the tabulated technical data on page 11 of this manual for specific requirements.

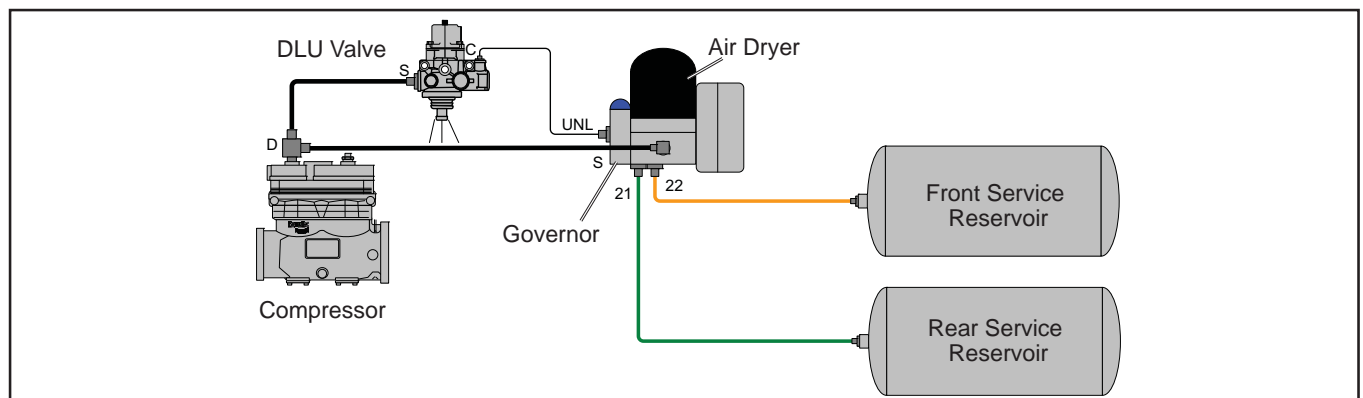

**FIGURE 6 - TYPICAL BENDIX® 360 (DLU) COMPRESSOR AIR CHARGING SYSTEM**

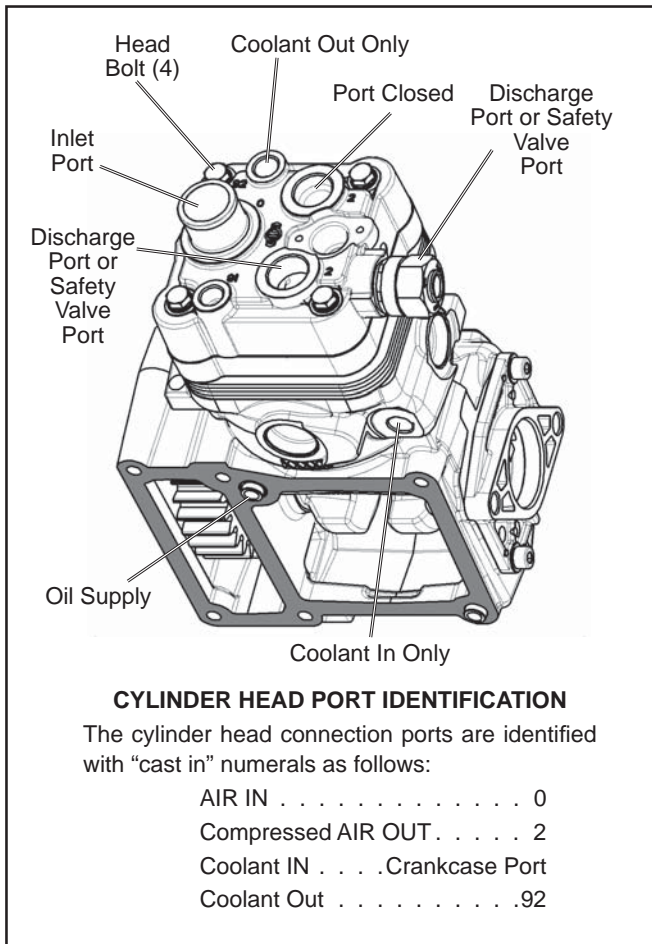

**FIGURE 7 - BENDIX® 360cc SINGLE CYLINDER COMPRESSOR PORT IDENTIFICATION**

**AIR INDUCTION**

The Bendix® 360cc Single Cylinder Compressors is only permitted to be naturally aspirated – use of engine turbocharger as an air source is not permitted.

**PREVENTATIVE MAINTENANCE**

Regularly scheduled maintenance is the single most important factor in maintaining the air brake charging system. Refer to **Table A: Maintenance Schedule and Usage Guidelines** in the troubleshooting section (page A-3) for a guide to various considerations that must be given to maintenance of the compressor and other related charging system components.

**Important Note:** Review the Bendix® Warranty Policy before performing any intrusive maintenance procedures. An extended warranty may be voided if intrusive maintenance is performed during this period.

**EVERY 6 MONTHS, 1800 OPERATING HOURS OR AFTER EACH 50,000 MILES WHICHEVER OCCURS FIRST, PERFORM THE FOLLOWING INSPECTIONS AND TESTS.**

**AIR INDUCTION**

A supply of clean air is one of the single most important factors in compressor preventive maintenance. Since the air supply for Bendix® 360cc Single Cylinder Compressor and engine is the engine air cleaner, periodic maintenance of the engine air filter is necessary.

Inspect the compressor air induction system each time engine air cleaner maintenance is performed.

1. Inspect the intake hose adapters for physical damage. Make certain to check the adapters at both ends of the intake hose or tubing.
2. Inspect the intake hose clamps and tighten them if needed.
3. Inspect the intake hose or line for signs of drying, cracking, chafing and ruptures and replace if necessary.
4. Inspect the compressor’s cast inlet tube for physical damage.

**COMPRESSOR COOLING**

Inspect the compressor discharge port, inlet cavity and discharge line for evidence of restrictions and carbon buildup. If more than 1/16" of carbon is found, thoroughly clean or replace the affected parts. In some cases, carbon buildup indicates inadequate cooling. Closely inspect the compressor cooling system. Check all compressor coolant lines for kinks and restrictions to flow. Minimum coolant line size is 3/8" I.D. Check coolant lines for internal clogging from rust scale. If coolant lines appear suspicious, check the coolant flow and compare to the tabulated technical data present in the back of this manual.

**LUBRICATION**

The compressor utilizes an internal oil feed design. Check the exterior of the compressor (i.e. around the mounting face) for the presence of oil seepage and refer to the troubleshooting section for appropriate tests and corrective action. Refer to the tabulated technical data in the back of this manual for oil pressure minimum values.

**OIL PASSING**

All reciprocating compressors pass a minimal amount of oil. Air dyers will remove the majority of oil before it can enter the air brake system. For particularly oil sensitive systems, the Bendix® PuraGuard® system can be used in conjunction with a Bendix® air dryer.

If compressor oil passing is suspected, refer to the *Troubleshooting section (starting on page A-1)* for the

symptoms and corrective action to be taken. In addition, Bendix has developed the “Bendix Air System Inspection Cup” or BASIC kit to help substantiate suspected excessive oil passing. The steps to be followed when using the BASIC kit are presented in APPENDIX B, on page A-16.

## COMPRESSOR DRIVE

Check for noisy compressor operation, which could indicate excessive drive component wear. Adjust and/or replace as necessary. Check all compressor mounting bolts and retighten evenly if necessary. Check for leakage. Repair or replace parts as necessary.

## CHARGING SYSTEM UNLOADING & GOVERNOR

**Note:** The Bendix® 360cc (DLU)-style single cylinder compressor does not contain components to unload the compressor. Therefore, the compressor pumps continuously. In most systems supplied by International, a turbo cut-off style air dryer, governor and discharge line unloader valve are used to unload the system (i.e. air is not being delivered to the brake system reservoirs). When system unloading occurs, air from the compressor will flow out the exhaust port of the discharge line unloader valve. Refer to Figure 6.

Test and inspect the unloading system (i.e. air dryer and governor) for proper operation and pressure settings.

1. Make certain the unloader system lines (illustrated in Figure 6) are connected and leak free.
2. Cycle the charging system between the loaded and unloaded mode several times. This can be achieved by applying the brakes to bleed down the system pressure. Make certain that the governor cuts-in (charging system resumes compressing air) at a minimum of 105 psi. Governor cut-out (charging system stops delivering air to the brake system reservoirs) should be approximately 15 - 20 psi greater than cut-in pressure. Adjust or replace the governor as required.
3. Note that the charging system cycles to the loaded and unloaded conditions promptly. If prompt action is not noted, repair or replace: the governor; the discharge line unloader valve; and/or the air dryer purge valve assembly.

## IMPORTANT NOTE

**Replacement air governors must have a minimum cut-in pressure of 100 psi.** The cut-in pressure is the lowest system pressure registered in the gauges before the compressor resumes compressing air.

## SERVICE TESTS

### GENERAL

The compressor operating and leakage tests listed below need not be performed on a regular basis. These tests should be performed when it is suspected that leakage is substantially affecting compressor buildup performance, or when it is suspected that the charging system is “cycling” between the loaded (pumping) and unloaded (charging system stops delivering air to the brake system reservoirs) modes due to unloader system leakage.

### IN-SERVICE OPERATING TESTS

#### ***Compressor Performance: Build-up Test***

This test is performed with the vehicle parked and the engine operating at maximum recommended governed speed. Fully charge the air system to governor cut-out (air dryer purges). Pump the service brake pedal to lower the system air pressure below 80 psi using the dash gauges. As the air pressure builds back up, measure the time from when the dash gauge passes 85 psi to the time it passes 100 psi. The time should not exceed 40 seconds. If the vehicle exceeds 40 seconds, test for (and fix) any air leaks and then re- test the compressor performance. If the vehicle does not pass the test the second time, use the Advanced Troubleshooting Guide for Air Brake Compressors, *starting on page A-1* of this document to assist your investigation of the cause(s).

**Note:** All new vehicles are certified using the FMVSS 121 test (paragraph S5.1.1) by the vehicle manufacturer, however the above test is a useful guide for in-service vehicles.

#### ***Optional Comparative Performance Check***

It may be useful to also conduct the above test with the engine running at high idle (instead of maximum governed speed), and record the time taken to raise the system pressure to a selected range (for example, from 90 to 120 psi, or from 100 to 120 psi, etc.) and record it in the vehicle's maintenance files. Subsequent build-up times throughout the vehicle's service life can then be compared to the first one recorded. (Note: the 40 second guide in the test above does not apply to this build-up time.) If the performance degrades significantly over time, you may use the Advanced Troubleshooting Guide for Air Brake Compressors, starting on page A-1 of this document, to assist in the investigation of the cause(s).

**Note:** When comparing build-up times, be sure to make an allowance for any air system modifications which would cause longer times, such as adding air components or reservoirs. Always check for air system leakage.

## LEAKAGE TESTS

See the standard Air Brake System and Accessory Leakage test on Page A-15 (Test 2).

**Note:** Leakage in the air supply system (components before the supply reservoir - such as the governor, air dryer, reservoir drain cocks, safety valve, and check valves) will not be registered on the vehicle dash gauges and must be tested separately. Refer to the various maintenance manuals for individual component leakage tests and the Bendix "Test and Checklist" published in the Bendix® Air Brake System Handbook (BW5057) and on the back of the Bendix® Dual Circuit Brake System Troubleshooting Card (BW1396).

## CYLINDER HEAD

Check the cylinder head gaskets for air leakage.

1. With the engine running, lower air system pressure to 60 psi and apply a soap solution around the cylinder head. Check the two gaskets between the cylinder head and the valve plate assembly, as well as the inlet reed valve/gasket between the valve plate assembly and crankcase for air leakage.
2. No leakage is permitted. If leakage is detected, replace the compressor or repair the cylinder head using the maintenance kit available from an authorized Bendix parts outlet.

## INLET & DISCHARGE VALVES

In order to test the inlet and discharge valves, it is necessary to have shop air pressure and an assortment of fittings. A soap solution is also required.

1. With the engine shut off, drain ALL air pressure from the vehicle.
2. Disconnect the inlet and discharge lines.
3. Apply 120-130 psi shop air pressure to the discharge port and then apply and release air pressure to the inlet port. Soap the inlet port and note that leakage at the inlet port does not exceed 200 scfm.

If excessive leakage is noted in Test 3, replace or repair the compressor using genuine Bendix replacements or maintenance kits available from any authorized Bendix parts outlet.

While it is possible to test for inlet and discharge leakage, it may not be practical to do so. Inlet and discharge valve leakage can generally be detected by longer compressor build-up and recovery times. Compare current compressor build-up times with the last several recorded times. Make certain to test for air system leakage, as described under "In-Service Operating Tests", before making a determination that performance has been lost.

## COMPRESSOR REMOVAL & DISASSEMBLY

### GENERAL

The following disassembly and assembly procedure is presented for reference purposes and pre-supposes that a rebuild or repair of the compressor is being undertaken. Several maintenance kits are available and the instructions provided with these parts and kits should be followed in lieu of the instructions presented here.

### MAINTENANCE KITS & SERVICE PARTS

#### BENDIX® 360CC SINGLE CYLINDER COMPRESSOR ONLY

- Compressor Seal Kit (Major) . . . . . K026807
- Compressor Seal Kit (Minor) . . . . . K051352
- Discharge Safety Valve Kit . . . . . K026809
- Compressor to Engine Mounting Face Sealant . . . . . Supplied by the Engine Manufacturer

### GENERAL SAFETY GUIDELINES

**WARNING! PLEASE READ AND FOLLOW THESE INSTRUCTIONS TO AVOID PERSONAL INJURY OR DEATH:**

**When working on or around a vehicle, the following general precautions should be observed at all times.**

1. Park the vehicle on a level surface, apply the parking brakes, and always block the wheels. Always wear safety glasses.
2. Stop the engine and remove ignition key when working under or around the vehicle. When working in the engine compartment, the engine should be shut off and the ignition key should be removed. Where circumstances require that the engine be in operation, EXTREME CAUTION should be used to prevent personal injury resulting from contact with moving, rotating, leaking, heated or electrically charged components.
3. Do not attempt to install, remove, disassemble or assemble a component until you have read and thoroughly understand the recommended procedures. Use only the proper tools and observe all precautions pertaining to use of those tools.
4. If the work is being performed on the vehicle's air brake system, or any auxiliary pressurized air systems, make certain to drain the air pressure from all reservoirs before beginning ANY work on the vehicle. If the vehicle is equipped with a Bendix® AD-IS® air dryer system or a dryer reservoir module, be sure to drain the purge reservoir.

5. Following the vehicle manufacturer's recommended procedures, deactivate the electrical system in a manner that safely removes all electrical power from the vehicle.
6. Never exceed manufacturer's recommended pressures.
7. Never connect or disconnect a hose or line containing pressure; it may whip. Never remove a component or plug unless you are certain all system pressure has been depleted.
8. Use only genuine Bendix® brand replacement parts, components and kits. Replacement hardware, tubing, hose, fittings, etc. must be of equivalent size, type and strength as original equipment and be designed specifically for such applications and systems.
9. Components with stripped threads or damaged parts should be replaced rather than repaired. Do not attempt repairs requiring machining or welding unless specifically stated and approved by the vehicle and component manufacturer.
10. Prior to returning the vehicle to service, make certain all components and systems are restored to their proper operating condition.
11. For vehicles with Automatic Traction Control (ATC), the ATC function must be disabled (ATC indicator lamp should be ON) prior to performing any vehicle maintenance where one or more wheels on a drive axle are lifted off the ground and moving.

## REMOVAL

In many instances it may not be necessary to remove the compressor from the vehicle when installing the various maintenance kits and service parts. The maintenance technician must assess the installation and determine the correct course of action. These instructions are general and are intended to be a guide. In some cases additional preparations and precautions are necessary. In all cases follow the instructions contained in the vehicle maintenance manual in lieu of the instructions, precautions and procedures presented in this manual.

1. Block the wheels of the vehicle and drain the air pressure from all the reservoirs in the system.
2. Drain the engine cooling system and the cylinder head of the compressor. Identify and disconnect all air, water and oil lines leading to the compressor.
3. Remove as much road dirt and grease from the exterior of the compressor as possible.
4. Remove the discharge fitting, if applicable, and note their position on the compressor to aid in reassembly.
5. Remove any supporting bracketing attached to the compressor and note their positions on the compressor to aid in reassembly.

6. Remove the 6 mounting bolts that retain the compressor to the side of the engine block. Note the position of the 6 mounting bolts. Two of the 6 bolts are shorter and must be installed in their original locations. Remove the compressor from the vehicle.
7. Inspect drive gear and associated drive parts for visible wear or damage. If the compressor drive gear is worn or damaged, the compressor must be replaced. Refer to the Engine Manufacturers service manual to address the associated engine drive parts.
8. If the compressor is being replaced stop here and proceed to "Installing the Compressor" at the end of the assembly procedure. (Note: Replacement compressors come with the drive gear pre-assembled on the compressor.)

## PREPARATION FOR DISASSEMBLY

*Refer to Figure 8 during the entire disassembly and assembly procedure.*

Place a clean rag over the openings that expose the gear and crankshaft / connecting rod assembly. No contamination is permitted in these areas.

Remove the balance of the road dirt and grease from the exterior of the compressor with a cleaning solvent. If the rear end cover (8) is being removed from the compressor under repair, mark it along with the two cap screws (7) in relation to the crankcase. It is also recommended to mark the relationship of the cylinder head (15), cooling plate (14), valve plate assembly (13), and crankcase.

A convenient method to indicate the above relationships is to use a metal scribe to mark the parts with numbers or lines. Do not use marking methods, such as chalk, that can be wiped off or obliterated during rebuilding.

Prior to disassembly, make certain that the appropriate kits are available.

## CYLINDER HEAD, COOLING PLATE & VALVE PLATE ASSEMBLY

1. Remove the washer (3) and discharge safety valve (2) from the cylinder head (15).
2. Remove the four hex head bolts (1) from the cylinder head (15).
3. Gently tap the cylinder head (15), cooling plate (14) and valve plate assembly (13) with a soft mallet to break the gasket seal between the valve plate assembly (13) and the crankcase. Lift the cylinder head (15) with cooling plate (14) and valve plate assembly (13) off the crankcase.
4. Remove the metal inlet reed valve/gasket (5).
5. Remove the crankcase o-ring (12) from a countersunk hole on the crankcase (11) deck.

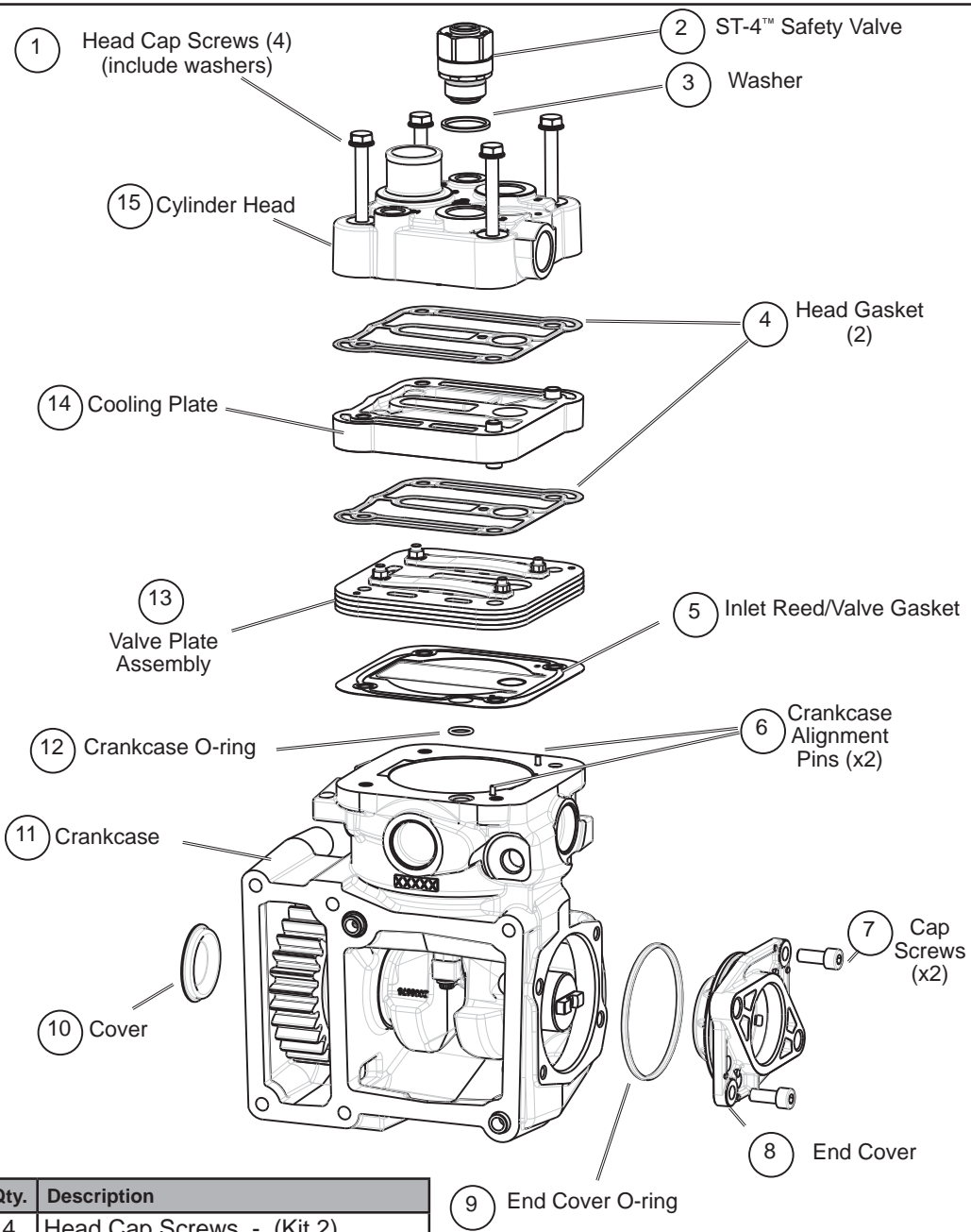

Item	Qty.	Description
1	4	Head Cap Screws - (Kit 2)
2	1	ST-4™ Safety Valve - (Kit 1)
3	1	Washer - (Kit 1)
4	2	Head Gaskets - (Kit 2)
5	1	Inlet Reed Valve/Gasket - (Kit 2)
6	2	Crankcase Alignment Pins
7	2	Cap Screws
8	1	End Cover
9	1	End Cover O-Ring (Kit 2 & 3)
10	1	Cover (Kit 2 & 3)
11	1	Crankcase
12	1	Crankcase O-ring (Kit 2)
13	1	Valve Plate Assembly
14	1	Cooling Plate
15	1	Cylinder Head

**Kit Notes:**  
**Kit 1:** Discharge Safety Valve Kit (K026809)  
**Kit 2:** Compressor Seal Kit (Major) (K026807)  
**Kit 3:** Compressor Seal Kit (Minor) (K051352)

FIGURE 8 – BENDIX® 60cc SINGLE CYLINDER COMPRESSOR EXPLODED VIEW



- Gently tap the cylinder head (15), cooling plate (14) and valve plate assembly (13) with a soft mallet to break the gasket seals. Then separate the cylinder head (15) from the cooling plate (14) and valve plate assembly (13), and remove and discard the two head gaskets (4) between them.

### CRANKCASE FRONT COVER

- Remove the cover (10) from the front of the crankcase. Use a sharp flat head screw driver or a scraper. Place the edge under the lip along the outside diameter of the cover. Pry the cover from the cast surface until the cover can be removed.

### REAR END COVER

- Note: There are two cap screws (7) used to retain the end cover to the crankcase. There are two longer cap screws (not shown in Figure 9) that are used to retain the auxiliary drive unit (i.e. hydraulic pump) via the end cover and torqued into the crankcase. If the auxiliary drive unit has already been removed, these two cap screws are no longer present on the end cover. Refer to Figure 9 to see location of the cap screws (7) in the end cover.
- Remove the two end cover cap screws (7) that secure the rear end cover to the crankcase.
- Remove the rear end cover (8) from the crankcase. Remove and discard the o-ring (9) from the end cover (8).

### CLEANING OF PARTS

#### GENERAL

All parts should be cleaned in a good commercial grade of solvent and dried prior to inspection.

#### CRANKCASE

- Carefully remove all sealant gasket material adhering to the machined face of the crankcase. See Figure 3. Make certain not to scratch or mar the mounting surface. Note: Keep the crankcase (11) opening covered to prevent any of the sealant material from entering. Repeat this process on the engine mounting face as well. Follow the instructions contained in the vehicle maintenance manual in lieu of the instructions and procedures presented in this manual.
- Carefully remove all gasket material adhering to the deck (top) of the crankcase. Remove any carbon deposits from the deck of the crankcase. Make certain not to scratch or mar the gasket surfaces.

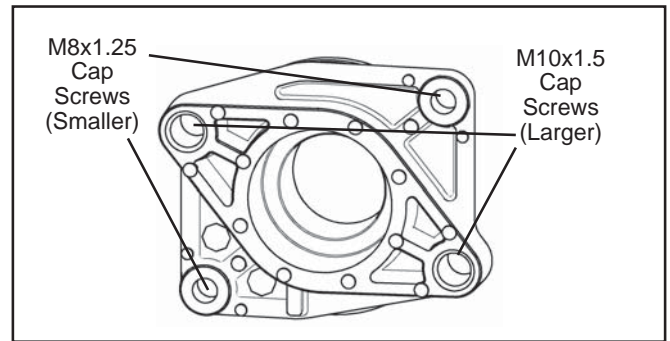

FIGURE 9 - REAR END COVER ATTACHMENT BOLTS

### CYLINDER HEAD, COOLING PLATE & VALVE PLATE ASSEMBLY

- Carefully remove all gasket material adhering to the cylinder head (15), cooling plate (14) and valve plate assembly (13). Make certain not to scratch or mar the gasket surfaces. Pay particular attention to the gasket surfaces of the cylinder head and cooling plate.
- Remove carbon deposits from the discharge and inlet cavities of the cylinder head, cooling plate and valve plate assembly. The cavities must be open and clear. Make certain not to damage the parts, while cleaning.
- Remove rust and scale from the cooling cavities and passages in the cylinder head, cooling plate and valve plate assembly and use shop air to clear debris from the passages.
- Check the threads in all cylinder head ports for galling (e.g. abrasion, chafing). Minor thread chasing (damage) is permitted.

### INSPECTION OF PARTS

#### CYLINDER HEAD, COOLING PLATE AND VALVE PLATE ASSEMBLY

- Carefully inspect the head gasket surfaces on the cylinder head (15) for deep gouges and nicks. Also, inspect the cylinder head for any cracks or port thread damage. If detected, the compressor must be replaced. If large amounts of carbon build-up are present in the discharge cavity such that it restricts the air flow through the cylinder head, the compressor should be replaced.
- Carefully inspect both sides of the head gasket surfaces on the cooling plate (14) for deep gouges and nicks. Also, inspect the cooling plate for any cracks or other damage. If damage is found, the compressor must be replaced.
- Carefully inspect the valve plate assembly (13) gasket surfaces (both sides) for deep gouges and nicks. Pay particular attention to the gasket surface. An inlet reed valve/gasket (5) is used between the valve plate assembly (13) and crankcase. These gasket surfaces must be smooth and free of all but the most minor scratches. If excessive marring or gouging is detected,

the compressor must be replaced. If large amounts of carbon build-up are present on the two main surfaces, in the two discharge valve holes or between the discharge valve and the discharge seat, the compressor should be replaced.

## REAR END COVER

Visually inspect for cracks and external damage. Check the crankshaft rear bearing diameter in the rear end cover (8) for excessive wear, flat spots or galling. Check the hydraulic pump attachment pilot and threaded holes for damage. Minor thread chasing is permitted, but do not re-cut the threads. If any of these conditions are found, replace the compressor.

## CRANKCASE

Check the cylinder head gasket surface on the deck (top) of the crankcase (11) for nicks, gouges, and marring. A metal gasket is used to seal the cylinder head to the crankcase. This surface must be smooth and free of all but the most minor scratching. If excessive marring or gouging is detected, the compressor must be replaced.

Check the condition of the countersunk hole on the deck of the crankcase (11) that retains the o-ring and prevents coolant leakage between the valve plate assembly and the crankcase. The surface in contact with the o-ring should be smooth and free of any scratches and gouges that could cause leakage around the o-ring.

## ASSEMBLY

General Note: All torques specified in this manual are assembly torques and typically can be expected to fall off after assembly is accomplished. Do not re-torque after initial assembly torques fall unless instructed otherwise. A compiled listing of torque specifications is presented on page 11.

## INCH POUNDS TO FOOT POUNDS

To convert inch pounds to foot pounds of torque, divide inch pounds by 12.

Example:  $\frac{12 \text{ Inch Pounds}}{12} = 1 \text{ Foot Pound}$

## FOOT POUNDS TO INCH POUNDS

To convert foot pounds to inch pounds of torque, multiply foot pounds by 12.

Example:  $1 \text{ Foot Pound} \times 12 = 12 \text{ Inch Pounds}$

## CRANKCASE FRONT COVER

1. Position the new cover (10) over the hole in the front of the crankcase. Using a rubber mallet, drive the cover into the hole in the front of the crankcase (11), until the outside diameter of the cover is flush with cast surface.

## REAR END COVER

1. Install the o-ring (9) on the rear end cover.
2. Orient the rear end cover (8) to the crankcase (11) using the reference marks made during disassembly. Carefully install the rear end cover in the crankcase (11) making certain not to damage the crankshaft bearing surface.
3. Install the two end cover cap screws (7). Refer to Figure 9 to ensure that the two cap screws (7) are installed in the proper crankcase (11) bolt holes. "Snug" the screws, then tighten to between 195 to 212 inch pounds (22-24 Nm).

## CYLINDER HEAD, COOLING PLATE & VALVE PLATE ASSEMBLY

1. Install the crankcase o-ring (12) into the slightly countersunk hole on the deck of the crankcase.
2. Note the position of the protruding crankcase (11) alignment pins on the deck (top) of the crankcase. Install the metal inlet reed valve/gasket (5) over the alignment pins on the crankcase; being careful not to disturb the crankcase o-ring (12).
3. Position the valve plate assembly (13) on the crankcase (11) so that the alignment pins in the crankcase fit into the corresponding holes in the valve plate assembly (13).
4. Position one of the embossed metal head gaskets (4) over the alignment bushings protruding from the cooling plate (14). Position the second embossed metal head gasket over the alignment bushings on the opposite side of the cooling plate (14). When properly positioned, the outline of the two embossed gaskets match the outline of the cooling plate.
5. Install the cooling plate with the head gaskets onto the valve plate assembly. Align the alignment bushings on the cooling plate over the oversized countersunk holes of the valve plate assembly. Again, when properly installed, the outline of the cooling plate matches the outline of the valve plate assembly.
6. Position and install the cylinder head (15) over the alignment bushings protruding from the cooling plate. When properly installed, the outline of the cylinder head assembly will match the outline of the cooling plate and valve plate assembly.

**Note:** To assist with correct installation, the alignment bushings only fit into two, of the four, cylinder head cap screws.

7. "Snug" the four hex head cylinder head cap screws (1) and snug them, then tighten evenly to a torque of 265 to 292 inch pounds (30-33 Nm) using a crossing pattern. **Note: A light film of oil should be applied to the thread of these bolts prior to installation. Oil should not be applied to any other bolts.**

8. Install the washer (3) and safety valve (2) in the top port (discharge port) of the cylinder head (15), then tighten to a torque of 59 to 66 foot pounds (80-90 Nm). This port can be identified by the number 2 cast into the cylinder head.

**INSTALLING THE COMPRESSOR**

1. Apply a liquid gasket sealant to the compressor / engine mounting interface (*Refer to Figure 3 for compressor mounting face*). Follow the “Engine or Vehicle Manufacturers guidelines for the proper liquid gasket sealant material and application procedure.
2. Secure the compressor on the engine mounting interface using the 6 mounting bolts. NOTE: There are 2 short bolts and 4 long bolts. Be sure the use the proper length bolt for the crankcase bolt holes. Run each of the bolts down finger tight, making sure not to smear the liquid gasket material on the sealing surface. Once the bolts are all finger tight; tighten the mounting bolts per Engine Manufacturers recommended torquing sequence and torque requirements.
3. Install any supporting brackets on the compressor in the same position(s) noted and marked during removal.
4. Inspect all air and coolant lines and fittings before reconnecting them to the compressor. Make certain o-ring seals are in good or new condition, the threads are clean and the fittings are free of corrosion. Replace as necessary.
5. Install the discharge and coolant fittings, if applicable, in the same position on the compressor noted and marked during disassembly. See the Torque Specifications for various fitting sizes and types of thread at the rear of this manual. Tighten all hose clamps.
6. Before returning the vehicle to service, perform the Operation and Leakage Tests specified in this manual. Pay particular attention to all lines and hoses disconnected during the maintenance and check for air, oil, and coolant leaks at compressor connections and the compressor engine interface. Also check for noisy operation.

**BENDIX® 360CC SINGLE CYLINDER COMPRESSOR SPECIFICATIONS**

Typical weight . . . . .	42 LBS (19.1 KG)
Number of cylinders . . . . .	1
Bore Diameter . . . . .	3.622 IN (92 MM)
Stroke . . . . .	2.126 IN (54 MM)
Calculated displacement at 1250 RPM . . . .	15.8 CFM
Flow Capacity @ 1800 RPM & 120 PSI . . . .	14.5 CFM
Flow Capacity @ 3000 RPM & 120 PSI . . . .	23.1 CFM
Approximate horsepower required:	
Loaded 1800 RPM at 120 PSIG . . . . .	5.2 HP
Loaded 1800 RPM at 0 psig (DLU) . . . . .	2.7 HP
Minimum coolant flow at maximum RPM . . .	2.64 GPM (10 LPM)
Maximum coolant temperature . . . . .	203°F (95°C)
Maximum inlet air temperature . . . . .	122°F (50°C)
Maximum system pressure. . . . .	150 PSI
Minimum oil pressure required . . . . .	10 PSI

**TORQUE SPECIFICATIONS**

Assembly Torques

M8x1.25-6g Cylinder Head Bolts. . . . .	265-292 In. Lbs. (30-33 Nm)
M10x1.5 End Cover Bolts . . . . .	195 to 213 In. Lbs. (22-24 Nm)
M26x1.5 Safety Valve . . . . .	59-66 ft. lbs. (80-90 Nm) Maximum
M26x1.5 Discharge Port Fittings . . . . .	66 ft. lbs. (90 Nm) Maximum
M16 x 1.5-6H Water Port Fittings . . . . .	33 ft. lbs. (45 Nm) Maximum



# Appendix A

## Advanced Troubleshooting Guide for Air Brake Compressors

The guide consists of an introduction to air brake charging system components, a table showing recommended vehicle maintenance schedules, and a troubleshooting symptom and remedy section with tests to diagnose most charging system problems.

### INDEX

Symptom	Page Number	Symptom	Page Number
<b>Air</b>		<b>Coolant</b>	
Air brake charging system:		Compressor leaks coolant (17.0).....	A-13
Slow build (9.0) .....	A-9-10	<b>Engine</b>	
Doesn't build air (10.0).....	A-11	Oil consumption (6.0) .....	A-9
Air dryer:		<b>Oil</b>	
Doesn't purge (14.0) .....	A-12	Oil Test Card results (1.0).....	A-4
Safety valve releases air (12.0) .....	A-12	Oil is present:	
Compressor:		On the outside of the compressor (2.0) .....	A-5
Constantly cycles (15.0) .....	A-12	At the air dryer purge/exhaust	
Leaks air (16.0) .....	A-13	or surrounding area (3.0) .....	A-5
Safety valve releases air (11.0) .....	A-11	In the supply reservoir (4.0) .....	A-6-8
Noisy (18.0) .....	A-13	At the valves (5.0).....	A-8
Reservoir:		At air dryer cartridge (7.0).....	A-9
Safety valve releases air (13.0) .....	A-12	In the ping tank or compressor	
		discharge aftercooler (8.0).....	A-9

#### Test Procedures

- (1) Oil Leakage at Head Gasket .....A-14
- (2) System Leakage .....A-14
- (3) Compressor Discharge and  
    Air Dryer Inlet Temperature.....A-15
- (4) Governor Malfunction .....A-14
- (5) Governor Control Line .....A-15
- (6) Compressor Unloader .....A-15
- BASIC™ Test Information ..... A-16-18

#### Maintenance & Usage Guidelines

Maintenance Schedule and  
Usage Guidelines (Table A) ..... A-3

# Introduction to the Air Brake Charging System

Powered by the vehicle engine, the **air compressor** builds the air pressure for the air brake system. The air compressor is typically cooled by the engine coolant system and lubricated by the engine oil supply.

This Bendix® 360cc compressor is a “discharge line unloader” (DLU)-style compressor, meaning that the compressor pumps continuously, unlike some compressor designs which use an “unloader” mechanism in the compressor head to switch from a pumping mode to a non-pumping mode. Instead, the control of air delivery to the vehicle’s air system is managed by using a separate discharge line unloader valve mounted in parallel with the compressor, a turbo cut-off style of air dryer and a governor (see Figure below). The discharge line unloader valve and governor control the brake system air pressure between a preset maximum and minimum pressure level by monitoring the pressure in the service (or “supply”) reservoir. When the air pressure becomes greater than that of the preset “cut-out”, the governor controls the discharge line unloader valve such that the air from the compressor flows through the exhaust of the discharge line unloader valve and to atmosphere (i.e. preventing air delivery to the reservoirs) and also causes the air dryer to purge. As the service reservoir air pressure drops to the “cut-in” setting of the governor, the governor returns the discharge line unloader valve back to building air mode and the air dryer to air drying mode.

As the atmospheric air is compressed, all the water vapor originally in the air is carried along into the air system, as well as a small amount of the lubricating oil as vapor.

The **duty cycle** is the ratio of time the compressor spends building air to the total engine running time. Air compressors are designed to build air (run “loaded”) up to 25% of the time. Higher duty cycles cause conditions that affect air brake charging system performance which may require additional maintenance. Factors that add to the duty cycle are: air suspension, additional air accessories, use of an

undersized compressor, frequent stops, excessive leakage from fittings, connections, lines, chambers or valves, etc. The **discharge line** allows the air, water-vapor and oil-vapor mixture to cool between the compressor and air dryer. The typical size of a vehicle’s discharge line, (see column 2 of Table A on page A-3) assumes a compressor with a normal (less than 25%) duty cycle, operating in a temperate climate. See Bendix and/or other air dryer manufacturer guidelines as needed.

When the **temperature** of the compressed air that enters the air dryer is within the normal range, the air dryer can remove most of the charging system oil. If the temperature of the compressed air is above the normal range, oil as oil-vapor is able to pass through the air dryer and into the air system. Larger diameter discharge lines and/or longer discharge line lengths can help reduce the temperature.

The discharge line must maintain a **constant slope** down from the compressor to the air dryer inlet fitting to avoid low points where ice may form and block the flow. If, instead, ice blockages occur at the air dryer inlet, insulation may be added here, or if the inlet fitting is a typical 90 degree fitting, it may be changed to a straight or 45 degree fitting. For more information on how to help prevent discharge line freeze-ups, see Bendix Bulletins TCH-08-21 and TCH-08-22 (see pages A-19-21). Shorter discharge line lengths or insulation may be required in cold climates.

The **air dryer** contains a filter that collects oil droplets, and a desiccant bed that removes almost all of the remaining water vapor. The compressed air is then passed to the air brake service (supply) reservoir. The oil droplets and the water collected are automatically purged when the governor reaches its “cut-out” setting.



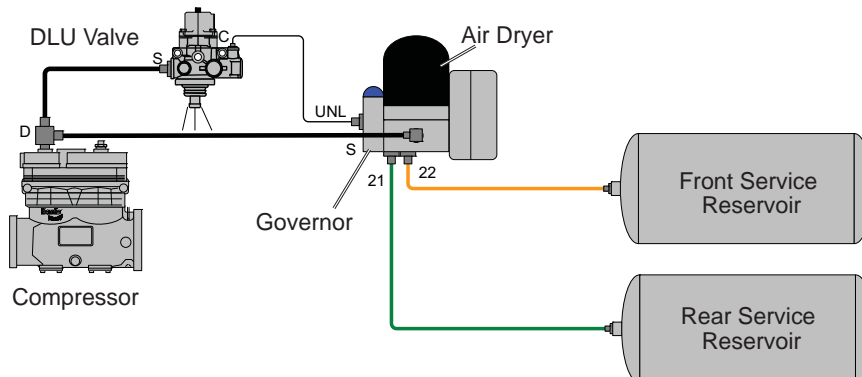

For vehicles with accessories that are sensitive to small amounts of oil, we recommended installation of a Bendix® PuraGuard® system filter, designed to minimize the amount of oil present.

**The Air Brake Charging System** supplies the compressed air for the braking system as well as other air accessories for the vehicle. The system usually consists of an air compressor, governor, discharge line, air dryer, and service reservoir.



# Table A: Maintenance Schedule and Usage Guidelines

Regularly scheduled maintenance is the single most important factor in maintaining the air brake charging system.

Vehicle Used for:	No. of Axles	Typical Compressors Spec'd	Column 2		Column 3	Column 4	Column 5
			I.D.	Length	Recommended Air Dryer Cartridge Replacement <sup>1</sup>	Recommended Reservoir Drain Schedule <sup>2</sup>	Acceptable Reservoir Oil Contents <sup>3</sup> at Regular Drain Intervals
<b>Low Air Use</b> Compressor with less than 15% duty cycle e.g. Line haul single trailer w/o air suspension, air over hydraulic brakes. 	5 or less	See Appendix E for Engine Application Matrix for Bendix®	1/2 in.	6 ft.	Every 3 Years	Recommended Every Month - Max of every 90 days	BASIC™ test acceptable range: 3 oil units per month. See appendix A.
Compressor with up to 25% duty cycle e.g. Line haul single trailer with air suspension, RV, school bus. 	5 or less		1/2 in.	9 ft.			
<b>High Air Use</b> Compressor with up to 25% duty cycle e.g. Double/triple trailer, open highway coach, (most) pick-up & delivery, yard or terminal jockey, off-highway, construction, loggers, concrete mixer, dump truck, fire truck. 	8 or less	Bendix® 360cc Single Cylinder and 720cc Two Cylinder Compressors for International Maxxforce™	1/2 in.	12 ft.	Every 2 Years	Every Month	BASIC™ test acceptable range: 5 oil units per month. See appendix A.
Compressor with up to 25% duty cycle e.g. City transit bus, refuse, bulk unloaders, low boys, urban region coach, central tire inflation. 	12 or less		3/4 in.	12 ft.			

For the BASIC™ Test Kit: Order Bendix P/N 5013711

**Footnotes:**

1. With increased air demand the air dryer cartridge needs to be replaced more often.
2. Use the drain valves to slowly drain all reservoirs to zero psi.
3. Allow the oil/water mixture to fully settle before measuring oil quantity.
4. To counter above normal temperatures at the air dryer inlet, (and resultant oil-vapor passing upstream in the air system) replace the discharge line with one of a larger diameter and/or longer length. This helps reduce the air's temperature. If sufficient cooling occurs, the oil-vapor condenses and can be removed by the air dryer. Discharge line upgrades are not covered under warranty. Note: To help prevent discharge line freeze-ups, shorter discharge line lengths or insulation may be required in cold climates. (See Bendix Bulletins TCH-08-21 and TCH-08-22, included in Appendix B, for more information.)

Note: Compressor and/or air dryer upgrades are recommended in cases where duty cycle is greater than the normal range (for the examples above).

For correct compressor upgrades consult Bendix.

\* See Appendix E for more an Application Matrix for Bendix® 360 and 720 air compressors.

# Air Brake Charging System Troubleshooting

How to use this guide:

Find the **symptom(s)** that you see, then move to the right to find the possible causes (“**What it may indicate**”) and remedies (“**What you should do**”).

Review the warranty policy before performing any intrusive compressor maintenance. Unloader or cylinder head gasket replacement and resealing of the bottom cover plate are usually permitted under warranty. Follow all standard safety procedures when performing any maintenance.

Look for:

 **Normal**

Normal - Charging system is working within normal range.

 **Check**

Check - Charging system needs further investigation.

**WARNING! Please READ and follow these instructions to avoid personal injury or death:**

When working on or around a vehicle, the following general precautions should be observed at all times.

1. Park the vehicle on a level surface, apply the parking brakes, and always block the wheels. Always wear safety glasses.
2. Stop the engine and remove ignition key when working under or around the vehicle. When working in the engine compartment, the engine should be shut off and the ignition key should be removed. Where circumstances require that the engine be in operation, EXTREME CAUTION should be used to prevent personal injury resulting from contact with moving, rotating, leaking, heated or electrically charged components.
3. Do not attempt to install, remove, disassemble or assemble a component until you have read and thoroughly understand the recommended procedures. Use only the proper tools and observe all precautions pertaining to use of those tools.
4. If the work is being performed on the vehicle's air brake system, or any auxiliary pressurized air systems, make certain to drain the air pressure from all reservoirs before beginning ANY work on the vehicle. If the vehicle is equipped with a Bendix® AD-IS® air dryer system or a dryer reservoir module, be sure to drain the purge reservoir.
5. Following the vehicle manufacturer's recommended procedures, deactivate the electrical system in a manner that safely removes all electrical power from the vehicle.
6. Never exceed manufacturer's recommended pressures.
7. Never connect or disconnect a hose or line containing pressure; it may whip. Never remove a component or plug unless you are certain all system pressure has been depleted.
8. Use only genuine Bendix® brand replacement parts, components and kits. Replacement hardware, tubing, hose, fittings, etc. must be of equivalent size, type and strength as original equipment and be designed specifically for such applications and systems.
9. Components with stripped threads or damaged parts should be replaced rather than repaired. Do not attempt repairs requiring machining or welding unless specifically stated and approved by the vehicle and component manufacturer.
10. Prior to returning the vehicle to service, make certain all components and systems are restored to their proper operating condition.
11. For vehicles with Automatic Traction Control (ATC), the ATC function must be disabled (ATC indicator lamp should be ON) prior to performing any vehicle maintenance where one or more wheels on a drive axle are lifted off the ground and moving.

Symptom:	What it may indicate:	What you should do:
----------	-----------------------	---------------------

**1.0 Oil Test Card Results**

Not a valid test.

**Discontinue using this test.**

Do not use this card test to diagnose compressor "oil passing" issues. They are subjective and error prone. Use only the Bendix® Air System Inspection Cup (BASIC™) test and the methods described in this guide for advanced troubleshooting.

**The Bendix® BASIC™ test should be the definitive method for judging excessive oil fouling/oil passing.** (See Appendix A, on page A-16 for a flowchart and expanded explanation of the checklist used when conducting the BASIC™ test.)

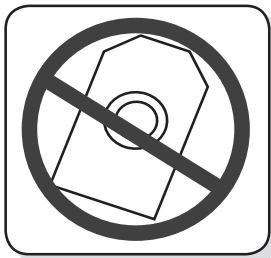

Bendix®  
BASIC™ Test





Symptom:	What it may indicate:	What you should do:
<b>2.0 Oil on the Outside of the Compressor</b>	Engine and/or other accessories leaking onto compressor.	Find the source and repair. Return the vehicle to service.
2.1 Oil leaking at compressor / engine connections:	(a) Leak at the front or rear (fuel pump, etc.) mounting flange.	⇒ Repair or replace as necessary. If the mounting bolt torques are low, replace the gasket.
	(b) Leak at air inlet fitting.	⇒ Replace the fitting gasket. Inspect inlet hose and replace as necessary.
	(c) Leak at air discharge fitting.	⇒ Replace gasket or fitting as necessary to ensure good seal.
	(d) Loose/broken oil line fittings.	⇒ Inspect and repair as necessary.
2.2 Oil leaking from compressor:	(a) Excessive leak at head gasket.	⇒ Go to Test 1 on page A-14.
	(b) Leak at bottom cover plate.	⇒ Reseal bottom cover plate using RTV silicone sealant.
	(c) Leak at internal rear flange gasket.	⇒ Replace compressor.
	(d) Leak through crankcase.	⇒ Replace compressor.
	(e) (If unable to tell source of leak.)	⇒ Clean compressor and check periodically.

**? Check**

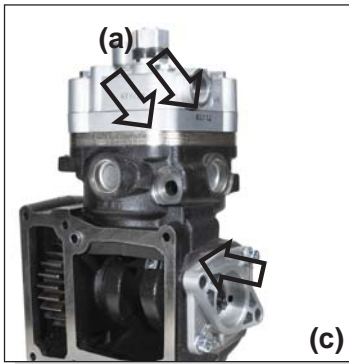

Head gaskets and rear flange gasket locations.

<b>3.0 Oil at air dryer purge/exhaust or surrounding area</b>	Air brake charging system functioning normally.	<p>⇒ Air dryers remove water and oil from the air brake charging system. Check that regular maintenance is being performed. Return the vehicle to service. An optional kit (Bendix piece number 5011327 for the Bendix® AD-IS® or AD-IP® air dryers, or 5003838 for the Bendix® AD-9® air dryer) is available to redirect the air dryer exhaust.</p> <p><b>✓ Normal</b></p>
---	---	---

**Symptom:****What it may indicate:****What you should do:****4.0 Oil in Supply or Service Reservoir (air dryer installed)**

(If a maintained Bendix® PuraGuard® system filter or Bendix® PuraGuard® QC oil coalescing filter is installed, call 1-800-AIR-BRAKE (1-800-247-2725) and speak to a Tech Team member.)



See Table A, on page A-3, for maintenance schedule information.

**Maintenance**

- (a) **If** air brake charging system maintenance **has not been performed**. That is, reservoir(s) **have not** been drained per the schedule in Table A on page **A-3**, Column 4 **and/or** the air dryer maintenance **has not** been performed as in Column 3.
- (b) **If** the vehicle maintenance **has been performed** as recommended in Table A on page **A-3**, some oil in the reservoirs is normal.



Drain all air tanks (reservoirs) into the Bendix® BASIC™ test cup. (Bendix kit P/N 5013711).

- ⇒ Drain all air tanks and check vehicle at next service interval using the Bendix® BASIC™ test. See Table A on page **A-3**, column 3 and 4, for recommended service schedule.

**? Check**

- ⇒ Drain all air tanks into Bendix® BASIC™ test cup (Bendix Air System Inspection Cup). If less than one unit of reservoir contents is found, the vehicle can be returned to service. **Note: If more than one oil unit of water (or a cloudy emulsion mixture) is present, change the vehicle's air dryer, check for air system leakage (Test 2, on page A-14), stop inspection and check again at the next service interval. See the BASIC™ test kit for full details.** If less than one "oil unit" of water (or water/cloudy emulsion mixture) is present, use the BASIC™ cup chart on the label of the cup to determine if the amount of oil found is within the acceptable level.
- ⇒ If within the normal range, return the vehicle to service. For vehicles with accessories that are sensitive to small amounts of oil, consider a Bendix® PuraGuard® QC oil coalescing filter.
- ⇒ If outside the normal range go to Symptom 4.0(c).
- Also see the Table A on page A-3, column 3 for recommended air dryer cartridge replacement schedule.

**Duty cycle too high**

- (c) Air brake system leakage.
- (d) Compressor may be undersized for the application.

The **duty cycle** is the ratio of time the compressor spends building air to total engine running time. Air compressors are designed to build air (to "run loaded") up to 25% of the time. Higher duty cycles cause conditions that affect air brake charging system performance which may require additional maintenance. Factors that add to the duty cycle are: air suspension, additional air accessories, use of an undersized compressor, frequent stops, excessive leakage from fittings, connections, lines, chambers or valves, etc.

- ⇒ Go to Test 2 on page **A-14**.
- ⇒ See Table A, column 1, on page **A-3** for recommended compressor sizes.
- ⇒ If the compressor is "too small" for the vehicle's role (for example, where a vehicle's use has changed or service conditions exceed the original vehicle or engine OE spec's) then upgrade the compressor. **Note:** The costs incurred (e.g. installing a larger capacity compressor, etc.) are not covered under original compressor warranty.
- ⇒ If the compressor is correct for the vehicle, go to Symptom 4.0 (e).

**Symptom:****What it may indicate:****What you should do:****4.0 Oil in Supply or Service Reservoir\* (air dryer installed) (continued)****Temperature**

(e) Air compressor discharge and/or air dryer inlet temperature too high.

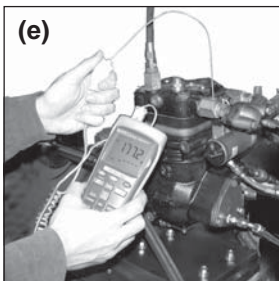

Testing the temperature at the discharge fitting.

(f) Insufficient coolant flow.



Inspecting the coolant hoses.

(g) Restricted discharge line.



Kinked discharge line shown.

⇒ Check temperature as outlined in Test 3 on page A-14. If temperatures are normal go to 4.0(h).

⇒ Inspect coolant line. Replace as necessary (I.D. is 1/2").

⇒ Inspect the coolant lines for kinks and restrictions and fittings for restrictions. Replace as necessary.

⇒ Verify coolant lines go from engine block to compressor and back to the water pump. Repair as necessary.

⇒ If discharge line is restricted or more than 1/16" carbon build-up is found, replace the discharge line. See Table A, column 2, on page A-3 for recommended size. Replace as necessary.

⇒ The discharge line must maintain a **constant slope** down from the compressor to the air dryer inlet fitting to avoid low points where ice may form and block the flow. If, instead, ice blockages occur at the air dryer inlet, insulation may be added here, or if the inlet fitting is a typical 90 degree fitting, it may be changed to a straight or 45 degree fitting. For more information on how to help prevent discharge line freeze-ups, see Bendix Bulletins TCH-08-21 and TCH-08-22 (Appendix B). Shorter discharge line lengths or insulation may be required in cold climates.

**Other**

(h) Restricted air inlet (not enough air to compressor).

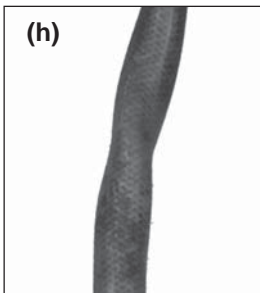

Partly collapsed inlet line shown.

⇒ Check compressor air inlet line for restrictions, brittleness, soft or sagging hose conditions etc. Repair as necessary. Inlet line size is 3/4 ID. Maximum restriction requirement for compressors is 25 inches of water.

⇒ Check the engine air filter and service if necessary (if possible, check the air filter usage indicator).

**? Check**

\*If a maintained Bendix® PuraGuard® system filter or Bendix® PuraGuard® QC oil coalescing filter is installed, call 1-800-AIR-BRAKE (1-800-247-2725) and speak to a Tech Team member.

**Symptom:****What it may indicate:****What you should do:****4.0 Oil in Supply or Service Reservoir\* (air dryer installed) (continued)****Other (cont.)**

- (i) Poorly filtered inlet air (poor air quality to compressor).



Inspect the engine air cleaner.

- (j) Governor malfunction or setting.
- (k) Compressor malfunction.

- ⇒ Check for leaking, damaged or defective compressor air inlet components (e.g. induction line, fittings, gaskets, filter bodies, etc.). Repair inlet components as needed. Note: Dirt ingestion will damage compressor and is not covered under warranty.

**? Check**

- ⇒ Go to Test 4 on page A-15.
- ⇒ If you found excessive oil present in the service reservoir in step 4.0 (b) above and you did not find any issues in steps 4.0 (c) through 4.0 (j) above, the compressor may be passing oil. Replace compressor. If still under warranty, follow normal warranty process. Note: After replacing a compressor, residual oil may take a considerable period of time to be flushed from the air brake system.

**Crankcase Flooding**

Consider installing a compressor bottom drain kit (where available) in cases of chronic oil passing where all other operating conditions have been investigated. Bendix compressors are designed to have a 'dry' sump and the presence of excess oil in the crankcase can lead to oil carryover.

\*If a maintained Bendix® PuraGuard® system filter or Bendix® PuraGuard® QC oil coalescing filter is installed, call 1-800-AIR-BRAKE (1-800-247-2725) and speak to a Tech Team member.

**5.0 Oil present at valves (e.g. at exhaust, or seen during servicing).**

Air brake system valves are required to tolerate a light coating of oil.

**✓ Normal**

- ⇒ A small amount of oil does not affect SAE J2024\*\* compliant valves.
- ⇒ Check that regular maintenance is being performed and that the amount of oil in the air tanks (reservoirs) is within the acceptable range shown on the Bendix® BASIC™ test cup (see also column 5 of Table A on page A-3). Return the vehicle to service.

For oil-sensitive systems, see page 16.



Genuine Bendix valves are all SAE J2024 compliant.

\*\* SAE J2024 outlines tests all air brake system pneumatic components need to be able to pass, including minimum levels of tolerance to contamination.

Symptom:	What it may indicate:	What you should do:
----------	-----------------------	---------------------

**6.0 Excessive oil consumption in engine.**

A problem with engine or other engine accessory.

⇒ See engine service manual.

**? Check**



The engine service manual has more information.

**7.0 Oil present at air dryer cartridge during maintenance.**

Air brake charging system is functioning normally.

⇒ Air dryers remove water and oil from the air brake charging system. A small amount of oil is normal. Check that regular maintenance is being performed and that the amount of oil in the air tanks (reservoirs) is within the acceptable range shown by the BASIC™ test (see also column 5 of Table A on page A-3). Replace the air dryer cartridge as needed and return the vehicle to service.

**✓ Normal**

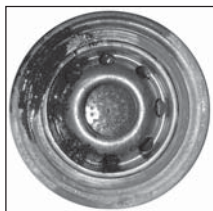

Oil shown leaking from an air dryer cartridge.

**8.0 Oil in ping tank or compressor discharge aftercooler.**

Air brake charging system is functioning normally.

⇒ Follow vehicle O.E. maintenance recommendation for these components.

**✓ Normal**

**9.0 Air brake charging system seems slow to build pressure.**

(a) Air brake charging system functioning normally.

⇒ Using dash gauges, verify that the compressor builds air system pressure from 85-100 psi in 40 seconds or less with engine at full governed rpm. Return the vehicle to service.

**✓ Normal**

(b) Air brake system leakage.

⇒ Go to Test 2 on page A-14.

(c) Compressor may be undersized for the application.

⇒ See Table A, column 1, on page A-3 for some typical compressor applications. If the compressor is "too small" for the vehicle's role, for example, where a vehicle's use has changed, then upgrade the compressor. Note: The costs incurred (e.g. installing a larger capacity compressor, etc.) are not covered under original compressor warranty.

*(d) is not applicable for the compressor featured in this SD sheet — information is shown for reference only.*

(d) Compressor unloader mechanism malfunction.

⇒ Go to Test 6 on page A-15.

(e) Damaged compressor head gasket.

⇒ An air leak at the head gasket may indicate a downstream restriction such as a freeze-up or carbon blockage and/or could indicate a defective or missing safety valve. Find blockage (go to 9.0(f) for details) and then replace the compressor. Do not reuse the safety valve without testing. See Symptom 12.0(a).

**Symptom:****What it may indicate:****What you should do:****9.0 Air brake charging system seems slow to build pressure. (continued)**

(f) Restricted discharge line.

**? Check**

Dash gauges.



Kinked discharge line shown.

**Engine Oil Quality**

Inadequate oil change intervals, the formulation of the oil and/or the quality of oil filter used can all lead to poor oil quality. These can increase the rate at which carbon builds up in the discharge line. Bendix recommends oil soot (solids) be maintained at less than 3%.

- ⇒ If discharge line is restricted:
  - ⇒ By more than 1/16" carbon build-up, replace the discharge line (see Table A, column 2, on page A-3 for recommended size) and go to Test 3 on page A-14.
  - ⇒ By other restrictions (e.g. kinks). Replace the discharge line. See Table A, column 2, on page A-3 for recommended size. Re-test for air build. Return vehicle to service or, if problem persists, go to 9.0(a).
- ⇒ The discharge line must maintain a **constant slope** down from the compressor to the air dryer inlet fitting to avoid low points where ice may form and block the flow. If, instead, ice blockages occur at the air dryer inlet, insulation may be added here, or if the inlet fitting is a typical 90 degree fitting, it may be changed to a straight or 45 degree fitting. For more information on how to help prevent discharge line freeze-ups, see Bendix Bulletins TCH-08-21 and TCH-08-22 (Appendix B). Shorter discharge line lengths or insulation may be required in cold climates.

(g) Restricted air inlet (not enough air to compressor).

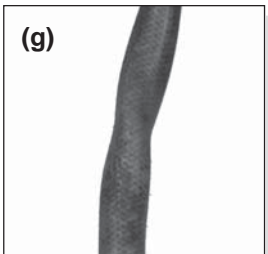
**? Check**

Partly collapsed inlet line shown.

(h) Poorly filtered inlet air (poor air quality to compressor).

**? Check**

(i) Compressor malfunction.

**? Check**

- ⇒ Check compressor air inlet line for restrictions, brittleness, soft or sagging hose conditions etc. Repair as necessary. Refer to vehicle manufacturer's guidelines for inlet line size.
- ⇒ Check the engine air filter and service if necessary (if possible, check the air filter usage indicator).
- ⇒ Check for leaking, damaged or defective compressor air inlet components (e.g. induction line, fittings, gaskets, filter bodies, etc.). Repair inlet components as needed. Note: Dirt ingestion will damage compressor and is not covered under warranty.
- ⇒ Replace the compressor only after making certain that none of the preceding conditions, 9.0 (a) through 9.0 (h), exist.

Symptom:	What it may indicate:	What you should do:
<b>10.0 Air charging system doesn't build air.</b>	(a) Governor malfunction*.	⇒ Go to Test 4 on page A-15.
	(b) Restricted discharge line.	⇒ See 9.0(f).
	(c) Air dryer heater malfunction: exhaust port frozen open.	⇒ Replace air dryer heater.
	(d) Compressor malfunction.	⇒ Replace the compressor only after making certain the preceding conditions do not exist.

\* Note: For the Bendix® DuraFlo 596™ air compressor, not only the governor, but also the SV-1™ synchro valve used would need to be tested. See Bulletin TCH-001-048.

**11.0 Compressor safety valve releases air (Compressor builds too much air).**

(a) Restricted discharge line.

**? Check**

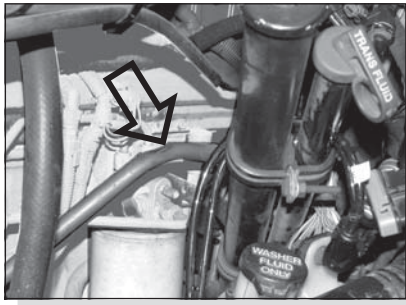

Damaged discharge line shown.

- ⇒ If discharge line is restricted:
  - ⇒ By more than 1/16" carbon build-up, replace the discharge line (see Table A, column 2, on page A-3 for recommended size) and go to Test 3 on page A-14.
  - ⇒ By other restrictions (e.g. kinks). Replace the discharge line. See Table A, column 2, on page A-3 for recommended size.
- ⇒ The discharge line must maintain a **constant slope** down from the compressor to the air dryer inlet fitting to avoid low points where ice may form and block the flow. If, instead, ice blockages occur at the air dryer inlet, insulation may be added here, or if the inlet fitting is a typical 90 degree fitting, it may be changed to a straight or 45 degree fitting. For more information on how to help prevent discharge line freeze-ups, see Bendix Bulletins TCH-08-21 and TCH-08-22 (Appendix B). Shorter discharge line lengths or insulation may be required in cold climates.
- ⇒ Inspect air lines and verify check valves are operating properly.
- ⇒ Ensure discharge line is installed into the inlet of the air dryer and delivery is routed to the service reservoir.
- ⇒ Verify relief pressure is 250 psi. Replace if defective.
- ⇒ Go to Test 6 on page A-15.
- ⇒ Go to Test 4 on page A-15.

- (b) Downstream air brake system check valves or lines may be blocked or damaged.
- (c) Air dryer lines incorrectly installed.
- (d) Compressor safety valve malfunction.
- (e) Compressor unloader mechanism malfunction.
- (f) Governor malfunction.

Symptom:	What it may indicate:	What you should do:
----------	-----------------------	---------------------

**12.0 Air dryer safety valve releases air.**

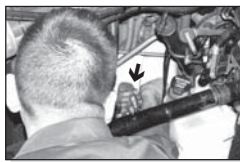
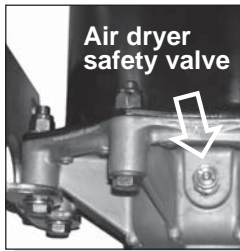

Technician removes governor.

- |   |  |
|---|--|
| (a) Restriction between air dryer and reservoir.                  | ⇒ Inspect delivery lines to reservoir for restrictions and repair as needed.   |
| (b) Air dryer safety valve malfunction.                           | ⇒ Verify relief pressure is at vehicle or component manufacturer specifications. Replace if defective.                   |
| (c) Air dryer maintenance not performed.                          | ⇒ See Maintenance Schedule and Usage Guidelines (Table A, column 3, on page A-3).  |
| (d) Air dryer malfunction.  | ⇒ Verify operation of air dryer. Follow vehicle O.E. maintenance recommendations and component Service Data information. |
| (e) Improper governor control line installation to the reservoir. | ⇒ Go to Test 5 on page A-15.   |
| (f) Governor malfunction.   | ⇒ Go to Test 4 on page A-15.   |

**13.0 Reservoir safety valve releases air.**

- |  |  |
|--|--|
| (a) Reservoir safety valve malfunction.        | ⇒ Verify relief pressure is at vehicle or component manufacturer's specifications (typically 150 psi). Replace if defective. |
| (b) Governor malfunction.                      | ⇒ Go to Test 4 on page A-15.   |
| (c) Compressor unloader mechanism malfunction. | ⇒ Go to Test 6 on page A-15.   |

**14.0 Air dryer doesn't purge. (Never hear exhaust from air dryer.)**

- |   |   |
|---|---|
| (a) Air dryer malfunction.  | ⇒ Verify operation of air dryer. Follow vehicle O.E. maintenance recommendations. |
| (b) Governor malfunction.   | ⇒ Go to Test 4 on page A-15.  |
| (c) Air brake system leakage.                                     | ⇒ Go to Test 2 on page A-14.  |
| (d) Improper governor control line installation to the reservoir. | ⇒ Go to Test 5 on page A-15.  |

**15.0 Compressor constantly cycles (compressor remains unloaded for a very short time.)**

- |  |  |
|--|--|
| (a) Air brake charging system maintenance not performed. | ⇒ Available reservoir capacity may be reduced by build-up of water etc. Drain and perform routine maintenance per Table A, columns 3 & 4, on page A-3. |
|--|--|

**? Check**

*(b) is not applicable for the compressor featured in this SD sheet — information is shown for reference only.*

- |  |  |
|--|--|
| (b) Compressor unloader mechanism malfunction.                 | ⇒ Go to Test 6 on page A-15.   |
| (c) Air dryer purge valve or delivery check valve malfunction. | ⇒ Verify operation of air dryer. Follow vehicle O.E. maintenance recommendations and component Service Data information. |
| (d) Air brake system leakage.                                  | ⇒ Go to Test 2 on page A-14.   |

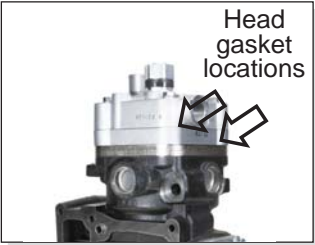

Symptom:	What it may indicate:	What you should do:
<b>16.0 Compressor leaks air</b>  <i>(b) is not applicable for the compressor featured in this SD sheet — information is shown for reference only.</i>	(a) Compressor leaks air at connections or ports.	⇒ Check for leaking, damaged or defective compressor fittings, gaskets, etc. Repair or replace as necessary.
	(b) Compressor unloader mechanism malfunction.	⇒ Go to Test 6 on page A-15.
	(c) Damaged compressor head gasket(s).	⇒ An air leak at the head gasket(s) may indicate a downstream restriction such as a freeze-up or carbon blockage and/or could indicate a defective or missing safety valve. Find blockage (go to 9.0(f) for details) and then replace the compressor. Do not re-use the safety valve without testing. See Symptom 12.0(a).
 Testing for leaks with soap solution.	 Head gasket locations	
<b>17.0 Compressor leaks coolant</b>	(a) Improperly installed plugs or coolant line fittings.	⇒ Inspect for loose or over-torqued fittings. Reseal and tighten loose fittings and plugs as necessary. If overtorqued fittings and plugs have cracked ports in the head, replace the compressor.
	(b) Damaged compressor head gasket.	⇒ An air leak at the head gasket may indicate a downstream restriction such as a freeze-up or carbon blockage and/or could indicate a defective or missing safety valve. Find blockage (go to 9.0(f) for details) and then replace the compressor. Do not re-use the safety valve without testing. See Symptom 12.0(a).
	(c) Porous compressor head casting.	⇒ If casting porosity is detected, replace the compressor.
<b>18.0 Noisy compressor (Multi-cylinder compressors only)</b>	(a) Damaged compressor.	⇒ Replace the compressor.

#### Other Miscellaneous Areas to Consider

This guide attempts to cover most compressor system problems. Here are some rare sources of problems not covered in this guide:

- Turbocharger leakage. Lubricating oil from leaking turbocharger seals can enter the air compressor intake and give misleading symptoms.

- Where a compressor does not have a safety valve installed, if a partial or complete discharge line blockage has occurred, damage can occur to the connecting rod bearings. Damage of this kind may not be detected and could lead to compressor problems at a later date.

# Tests

## Test 1: Excessive Oil Leakage at the Head Gasket

Exterior leaks at the head gasket are not a sign that oil is being passed into the air charging system. Oil weepage at the head gasket does not prevent the compressor from building air.

Observe the amount of weepage from the head gasket.

If the oil is only around the cylinder head area, it is acceptable (return the vehicle to service), but, if the oil weepage extends down to the nameplate area of the compressor, the gasket can be replaced.



## Test 2: Air Brake System and Accessory Leakage

Inspect for air leaks when working on a vehicle and repair them promptly.

Park the vehicle on level ground and chock wheels. Build system pressure to governor cut-out and allow the pressure to stabilize for one minute.

**Step 1:** Observe the dash gauges for two additional minutes without the service brakes applied.

**Step 2:** Apply the service brakes and allow the pressure to stabilize. Continue holding for two minutes (you may use a block of wood to hold the

pedal in position.) Observe the dash gauges.

If you see **any noticeable decrease** of the dash air gauge readings (i.e. more than 4 psi, plus two psi for each additional trailer) during either two minute test, **repair the leaks** and repeat this test to confirm that they have been repaired.

Air leaks can also be found in the charging system, parking brakes, and/or other components - inspect and repair as necessary.

## Test 3: Air Compressor Discharge Temperature and Air Dryer Inlet Temperature\*

**Caution:** The temperatures used in this test are not normal vehicle conditions.

Above normal temperatures can cause oil (as vapor) to pass through the air dryer into the air brake system.

This test is run with the engine at normal operating temperature, with engine at max. rpm. If available, a dyno may be used.

1. Allow the compressor to build the air system pressure to governor cut-in.
2. Pump the brakes to bring the dash gauge pressure to 90 psi.
3. Allow the compressor to build pressure from 95 to 105 psi gauge pressure and maintain this pressure range by cycling the brakes for **five (5) minutes**.

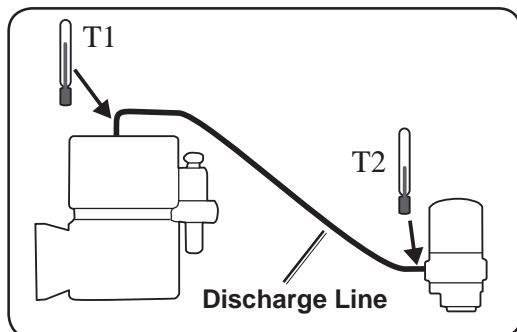

(\* Note that only vehicles that have passed Test 2 would be candidates for this test.)

4. Then, while maintaining max rpm and pressure range, measure and **record the surface temperature** of the **fittings**:
  - ⇒ at the compressor discharge port. (T1).
  - ⇒ at the air dryer inlet fitting. (T2).
 Use a touch probe thermocouple for measuring the temperature.
5. See table below.
6. Re-test before returning the vehicle to service.

T1 Compressor Discharge Fitting	T2 Air Dryer Inlet Fitting	Action
under 360°F	under 200°F	Temperatures are within normal range for this test, check other symptoms. Go to 4.0 (h).
under 360°F	over 200°F	This could indicate a discharge line problem (e.g. restriction). Call 1-800-AIR-BRAKE (1-800-247-2725) and speak with our Tech Team.
over 360°F	—	Compressor is running hot. Check coolant 4(f) and/or discharge line 4(g).

## Tests (continued)

### Test 4: Governor Malfunction

1. Inspect control lines to and from the governor for restrictions (e.g. collapsed or kinked). Repair as necessary.
2. Using a calibrated external gauge in the

- supply reservoir, service reservoir, or reservoir port of the D-2<sup>®</sup> governor, verify cut-in and cut-out pressures are within vehicle OEM specification.
3. If the governor is malfunctioning, replace it.

### Test 5: Governor Control Line

1. Ensure that the governor control line from the reservoir is located at or near the top of the reservoir. (This line, if located near the bottom of the reservoir, can become blocked or restricted by the reservoir contents e.g. water or ice.)

2. Perform proper reservoir drain intervals and air dryer cartridge maintenance per Maintenance Schedule and Usage Guidelines (Table A on page A-3).
3. Return the vehicle to service.

### Test 6: Compressor Unloader Leakage

**Bendix<sup>®</sup> Compressors:** Park vehicle, chock wheels, and follow all standard safety procedures. Remove the governor and install a fitting to the unloader port. Add a section of air hose (min 1 ft long for a 1/2" diameter line) and a gauge to the fitting followed by a shut-off valve and an air source (shop air or small air tank). Open the

shut-off and charge the unloader port by allowing air pressure to enter the hose and unload the compressor. Shut off the air supply and observe the gauge. A steady reading indicates no leakage at the unloader port, but a falling reading shows that the unloader mechanism is leaking and needs to be serviced.

*Note: This Test is not applicable for the compressor featured in this SD sheet — information is shown for reference only.*

Appendix B: Information about the BASIC™ Test Kit (Bendix P/N 5013711)

**Bendix® Air System Inspection Cup (BASIC™) Test Information**

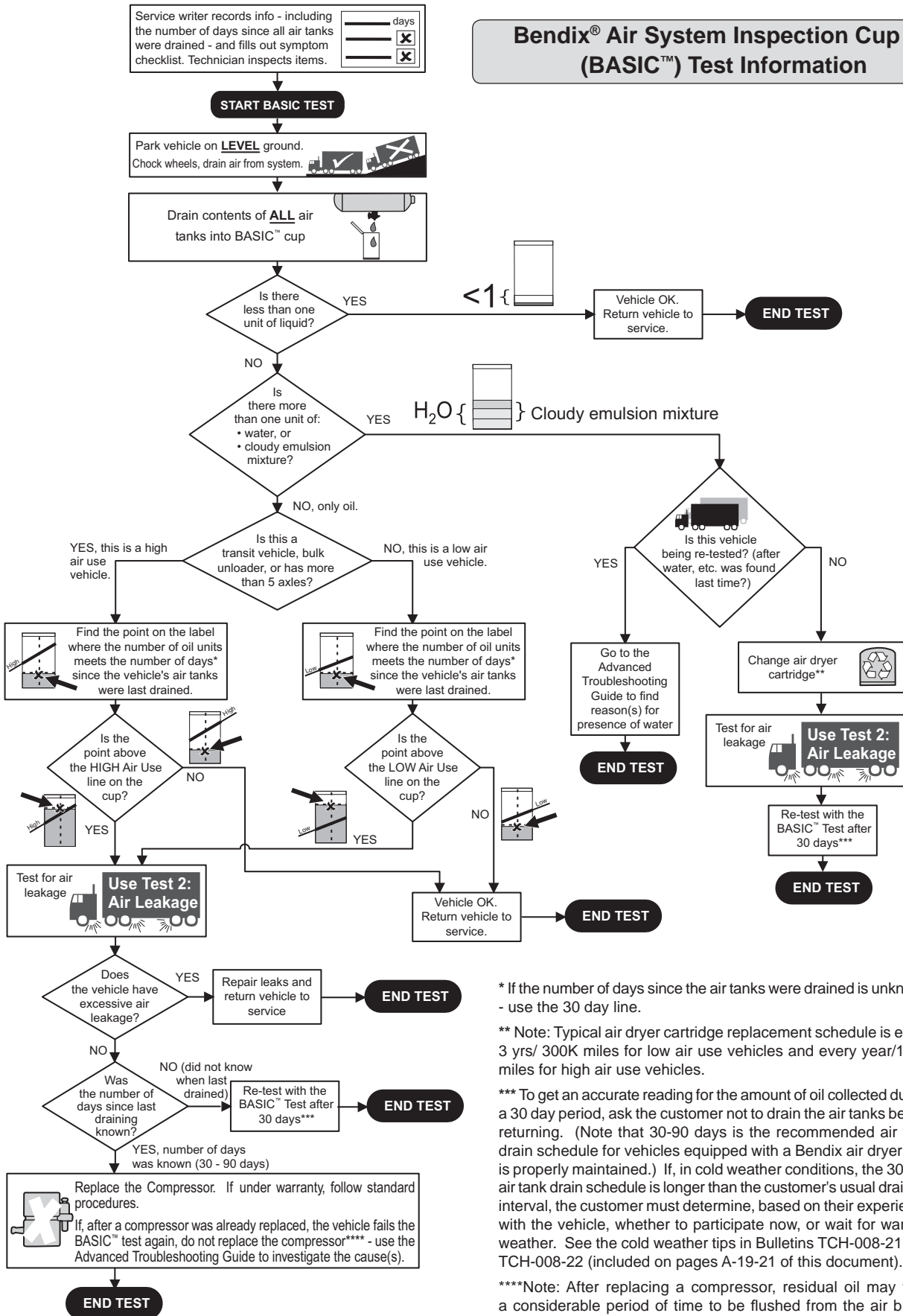

\* If the number of days since the air tanks were drained is unknown - use the 30 day line.

\*\* Note: Typical air dryer cartridge replacement schedule is every 3 yrs/ 300K miles for low air use vehicles and every year/100K miles for high air use vehicles.

\*\*\* To get an accurate reading for the amount of oil collected during a 30 day period, ask the customer not to drain the air tanks before returning. (Note that 30-90 days is the recommended air tank drain schedule for vehicles equipped with a Bendix air dryer that is properly maintained.) If, in cold weather conditions, the 30 day air tank drain schedule is longer than the customer's usual draining interval, the customer must determine, based on their experience with the vehicle, whether to participate now, or wait for warmer weather. See the cold weather tips in Bulletins TCH-008-21 and TCH-008-22 (included on pages A-19-21 of this document).

\*\*\*\*Note: After replacing a compressor, residual oil may take a considerable period of time to be flushed from the air brake system.

Appendix B continued: Information about the BASIC™ Test Kit (Bendix P/N 5013711)

Filling in the Checklist for the Bendix® Air System Inspection Cup (BASIC™) Test

Note: Follow all standard safety precautions. For vehicles using a desiccant air dryer.

The Service Writer fills out these fields with information gained from the customer

Number of Days Since Air Tanks Were Last Drained: \_\_\_\_\_ Date: \_\_\_\_\_ Vehicle #: \_\_\_\_\_  
 Engine SN \_\_\_\_\_ Vehicle Used for: \_\_\_\_\_ Typical Load: \_\_\_\_\_ (lbs.)  
 No. of Axles: \_\_\_\_ (tractor) \_\_\_\_ (trailer) No. of Lift Axles: \_\_\_\_ Technician's Name: \_\_\_\_\_

Customer's (Please check all that apply)	Checklist for Technician Have you confirmed complaint? ↓
"Relay valve <input type="checkbox"/> leaks oil / <input type="checkbox"/> malfunctions"	<input type="checkbox"/> no <input type="checkbox"/> yes*
"Dash valve <input type="checkbox"/> leaks oil / <input type="checkbox"/> malfunctions"	<input type="checkbox"/> no <input type="checkbox"/> yes*
<input type="checkbox"/> "Air dryer leaks oil"	<input type="checkbox"/> no <input type="checkbox"/> yes*
<input type="checkbox"/> "Governor malfunction"	<input type="checkbox"/> no <input type="checkbox"/> yes*
<input type="checkbox"/> "Oil in gladhands"	<input type="checkbox"/> no <input type="checkbox"/> yes*
how much oil did you find? _____	
<input type="checkbox"/> "Oil on ground or vehicle exterior"	<input type="checkbox"/> no <input type="checkbox"/> yes*
amount described: _____	
<input type="checkbox"/> "Short air dryer cartridge life"	
replaces every: _____ <input type="checkbox"/> miles, <input type="checkbox"/> kms, or <input type="checkbox"/> months	
<input type="checkbox"/> "Oil in air tanks" amount described: _____	
We will measure amount currently found when we get to step B of the test.	
<input type="checkbox"/> "Excessive engine oil loss" amount described: _____	
Is the engine leaking oil?	<input type="checkbox"/> no <input type="checkbox"/> yes*
Is the compressor leaking oil?	<input type="checkbox"/> no <input type="checkbox"/> yes*
<input type="checkbox"/> Other complaint: _____	
<input type="checkbox"/> No customer complaint.	

The Service Writer also checks off any complaints that the customer makes to help the Technician in investigating.

The Technician checks boxes for any of the complaints that can be confirmed.

\* Note: A confirmed complaint above **does NOT** mean that the compressor must be replaced. The full BASIC™ test below will investigate the facts.

**BASIC™ test starts here:**

**STEP A - Select one:**

- This is a low air use vehicle: Line haul (single trailer) with 5 or less axles, or
  - This is a high air use vehicle: Garbage truck, transit bus, bulk unloader, or line haul with more than 5 axles.
- Then go to Step B.**

The Technician selects the air use category for the vehicle. This decides which of the two acceptance lines on the cup will be used for the test below.

**STEP B - Measure the Charging System Contents**

1. Park and chock vehicle on level ground. Drain the air system by pumping the service brakes.
2. Completely drain **ALL** the air tanks into a single BASIC™ cup.
3. If there is less than one unit of contents total, end the test now and return the vehicle to service. Vehicle passes.
4. **If more than one oil unit of water (or a cloudy emulsion mixture) is found:**
  - (a) Change the vehicle's air dryer cartridge - see Footnote 1,
  - (b) Conduct the 4 minute leakage test (Step D),
  - (c) **STOP the inspection, and check the vehicle again after 30 days** - see Footnote 2.



For an accurate test, the contents of all the air tanks on the vehicle should be used.

**Note for returning vehicles that are being re tested after a water/cloudy emulsion mixture was found last time and the air dryer cartridge replaced:** If more than one oil unit of water or a cloudy emulsion mixture is found **again**, stop the BASIC™ test and consult the air dryer's Service Data sheet troubleshooting section.

**Otherwise, go to Step C.**

**Footnote 1:** Note: Typical air dryer cartridge replacement schedule is every 3 yrs/ 300K miles for low air use vehicles and every year/100K miles for high air use vehicles.

**Footnote 2:** To get an accurate reading for the amount of oil collected during a 30 day period, ask the customer not to drain the air tanks before returning. (Note that 30-90 days is the recommended air tank drain schedule for vehicles equipped with a Bendix air dryer that are properly maintained.) If, in cold weather conditions, the 30 day air tank drain schedule is longer than the customer's usual draining interval, the customer must determine, based on its experience with the vehicle, whether to participate now, or wait for warmer weather. See the cold weather tips in Bulletins TCH-008-21 and TCH-008-22 (included in Appendix B of the advanced troubleshooting guide).

Appendix B continued: Information about the BASIC™ Test Kit (Bendix P/N 5013711)

Filling in the Checklist for the Bendix® Air System Inspection Cup (BASIC™) Test

Note: Follow all standard safety precautions. For vehicles using a desiccant air dryer.

**STEP C - How to Use the BASIC™ Test**

The Technician uses the chart (label) on the BASIC™ test cup to help decide the action to take, based on the amount of oil found. Use the lower acceptance line for low air use vehicles, and upper line for high air use vehicles (from Step A).

1. Record days since air tanks were last drained. _____ days	2. Record amount of oil found: _____ units	3. Action to take
If number of days is: 30-60 days (high air use) or 30-90 days (low air use) →	if oil level is <b>at or below</b> acceptance line for number of days →	<b>System OK. Return to service.</b> <b>STOP TEST</b>
	if oil level is <b>above</b> acceptance line for number of days →	<b>Go to Step D</b>
Otherwise . . . → (if the number of days is unknown, or outside the limits above)	if oil level is <b>at or below</b> 30-day acceptance line →	<b>System OK. Return to service.</b> <b>STOP TEST</b>
	if oil level is <b>above</b> 30-day acceptance line →	<b>Stop inspection. Test again after 30 days. See Footnote 2.</b> <b>STOP + CK.</b>

**BASIC™ Test Example**

An oil level of 4 units in a sixty-day period is within the acceptance area (at or below the line) for both low and high air use vehicles. Return the vehicle to service.

The Technician looks for the point where the number of days since the air tanks were drained meets the oil level. If it is at or below the (low or high use) acceptance line, the vehicle has passed the test. If the point is above the line then go to the leakage test.

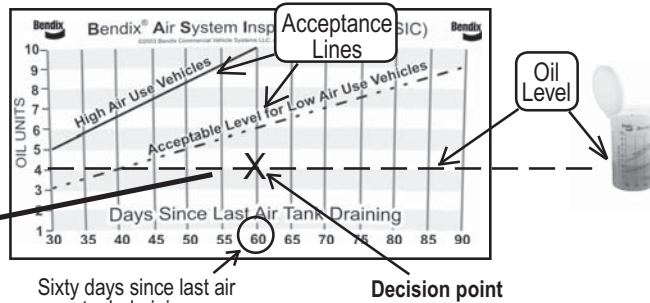

Air leakage is the number one cause of compressors having to pump excessive amounts of air, in turn run too hot and pass oil vapor along into the system. Here the Technician conducts a four-minute test to see if leakage is a problem with the vehicle being tested.

**STEP D - Air Brake System Leakage Test**

Park the vehicle on level ground and chock wheels. Build system pressure to governor cut-out and allow the pressure to stabilize for one minute.

- 1: Observe the dash gauges for two additional minutes without the service brakes applied.
- 2: Apply service brakes for two minutes (allow pressure to stabilize) and observe the dash gauges.

If you see any noticeable decrease of the dash air gauge readings, repair leaks. Repeat this test to confirm that air leaks have been repaired and return vehicle to service. Please repeat BASIC™ test at next service interval. Note: Air leaks can also be found in the charging system, parking brakes, and/or other components - inspect and repair as necessary.

**If no air leakage was detected, and if you are conducting this test after completing Step C, go to Step E.**

**STEP E - If no air leakage was detected in Step D**

Replace the compressor.

Note: If the compressor is within warranty period, please follow standard warranty procedures. Attach the completed checklist to warranty claim.

The Technician only reaches Step E if the amount of oil found, or the amount of time since the air tanks were last drained exceeds the acceptance level, AND the vehicle passes the four-minute leakage test (no noticeable leakage was detected).

# Technical Bulletin



Bulletin No: TCH-008-021

Effective Date: 3-5-2010

Cancels: PRO-08-21 dated 2-6-2008

Page: 1 of 2

## Subject: Air Brake System - Cold Weather Operation Tips

As the cold weather approaches, operators and fleets alike begin to look to their vehicles with an eye toward "winterization", and particularly what can be done to guard against air system freeze-up. Here are some basic "Tips" for operation in the cold weather.

### Engine Idling

Avoid idling the engine for long periods of time! In addition to the fact that most engine manufacturers warn that long idle times are detrimental to engine life, winter idling is a big factor in compressor discharge line freeze-up. Discharge line freeze-ups account for a significant number of compressor failures each year. The discharge line recommendations under "Discharge Lines" are important for all vehicles, but are especially so when some periods of extended engine idling can not be avoided.

### Discharge Lines

The discharge line should slope downward from the compressor discharge port without forming water traps, kinks, or restrictions. Cross-overs from one side of the frame rail to the other, if required, should occur as close as possible to the compressor.

### Dryer Inlet Temperature

The dryer inlet air temperature should typically be within the range of no more than 160°F and no less than 45°F above low ambient (surrounding) temperature to prevent freeze-ups. (For example, if low ambient is minus 40°F, the dryer inlet must be above 5°F.) Lower dryer inlet temperatures should be avoided to minimize the risk of freeze-up upstream of the air dryer. Higher temperatures should also be avoided to minimize the risk of heat damage to the air dryer seals and to avoid a loss of drying performance.

### Compressor Line Size

The line size and length is established by the vehicle manufacturer and should not be altered without the vehicle manufacturers approval. As a reference, the line length from the compressor to the air dryer should be less than 16 feet and the minimum line sizes should be as follows:

Minimum Length	Minimum I.D.	Application
6 ft.	1/2 in.	Low Compressor Duty Cycle Applications (0-20%)
10 ft.	5/8 in.	High Compressor Duty Cycle Applications (20-40%)

### Line Insulation

To guard against freeze-ups in Low Duty Cycle applications, the discharge line can be insulated if it is greater than 9 feet in length. The line can only be insulated back to 9 feet and a maximum of 3 feet. For example, if the line is 10 feet, insulate the fitting and the last one foot of the line. If the line is 15 feet, insulate the fitting and the last 3 feet of the line.

**System Leakage**

Check the air brake system for excessive air leakage using the Bendix “Dual System Air Brake Test and Check List” (BW1279). Excessive system leakage causes the compressor to “pump” more air and also reduce the life of the air dryer desiccant cartridge.

**Reservoir Draining (System without an Air Dryer)**

Routine reservoir draining is the most basic step in reducing the possibility of freeze-up. All reservoirs in a brake system can accumulate water and other contamination and must be drained! The best practice is to drain all reservoirs daily if the air brake system does not include an air dryer. When draining reservoirs; turn the ENGINE OFF and drain ALL AIR from the reservoir, better still, open the drain cocks on all reservoirs and leave them open over night to assure all contamination is drained (reference Service Data Sheet SD-04-400 for Bendix Reservoirs). If automatic drain valves are installed, check their operation before the weather turns cold (reference Service Data Sheet SD-03-2501 for Bendix® DV-2™ Automatic Drain Valves). It should be noted that, while the need for daily reservoir draining is eliminated through the use of an automatic drain valve, periodic manual draining is still required.

**Reservoir Draining (System with an Air Dryer)**

Daily reservoir draining should not be performed on systems with an air dryer. This practice will cause the dryer to do excessive work (i.e. build pressure from 0 -130 psi instead of the normal 110-130 psi).

**Alcohol Evaporator or Injector Systems**

Bendix Commercial Vehicle Systems LLC discourages the use of alcohol in the air brake system as a means of preventing system freeze-up in cold temperatures. Studies indicate that using alcohol and alcohol based products sold for this purpose removes the lubrication from the components of the air braking system. In addition, the materials used for the internal seals of the air system components may be adversely impacted by the residue that some anti-freeze additives leave behind. Both are detrimental to air system component life expectancy, causing premature wear. Because of this, Bendix® air system components warranty will be void if analysis shows that alcohol was added to the air brake system.

Alcohol is not an acceptable substitute for having adequate air drying capacity. If the air dryer is maintained in accordance with the manufacturer’s recommended practices and moisture is found to be present in the system reservoirs, more drying capacity is required. Bendix has several viable options including extended purge air dryers, extended purge tandem dryers in parallel with common control, and air dryers arranged to provide continuous flow as with the Bendix® EverFlow® continuous flow air dryer module. To address concerns with contaminants in trailer air brake systems, the Bendix® Cyclone DuraDrain™ water separator and the Bendix® System-Guard® trailer air dryer are available. Refer to Bendix Technical Bulletin TCH-008-042 “Alcohol in the Air Brake System” for additional information.

**Air Dryers**

Make certain air brake system leakage is within the limits stated in BW1279. Check the operation and function of the air dryer using the appropriate Service Data Sheet for the air dryer.

<b>Air Dryer</b>	<b>Service Data Sheet</b>
AD-2® air dryer	SD-08-2403
AD-4® air dryer	SD-08-2407
AD-9® air dryer	SD-08-2412
AD-IP® air dryer	SD-08-2414
AD-IS® air dryer	SD-08-2418
AD-IS® EverFlow® air dryer	SD-08-2417
AD-SP® air dryer	SD-08-2415
Cyclone DuraDrain™ water separator	SD-08-2402
PuraGuard® QC system filter	SD-08-187B
Trailer System-Guard® air dryer	SD-08-2416

Bendix literature is available to order or download on Bendix.com





# Technical Bulletin



Bulletin No.: TCH-008-022

Effective Date: 1/1/1994

Page: 1 of 1

## Subject: **Additional Cold Weather Operation Tips for the Air Brake System**

Last year we published Bulletin PRO-08-21 which provided some guidelines for "winterizing" a vehicle air brake system. Here are some additional suggestions for making cold weather vehicle operation just a little more bearable.

### **Thawing Frozen Air Lines**

The old saying; "Prevention is the best medicine" truly applies here! Each year this activity accounts for an untold amount of unnecessary labor and component replacement. Here are some Do's and Don'ts for prevention and thawing.

#### **Do's**

1. Do maintain freeze prevention devices to prevent road calls. Don't let evaporators or injectors run out of methanol alcohol or protection will be degraded. Check the air dryer for proper operation and change the desiccant when needed.
2. Do thaw out frozen air lines and valves by placing the vehicle in a warmed building. This is the only method for thawing that will not cause damage to the air system or its components.
3. Do use dummy hose couplings on the tractor and trailer.
4. Do check for sections of air line that could form water traps. Look for "drooping" lines.

#### **Don'ts**

1. Do not apply an open flame to air lines and valves. Beyond causing damage to the internal nonmetallic parts of valves and melting or burning non-metallic air lines. **WARNING: THIS PRACTICE IS UNSAFE AND CAN RESULT IN VEHICLE FIRE!**
2. Do not introduce (pour) fluids into air brake lines or hose couplings ("glad hands"). Some fluids used can cause immediate and severe damage to rubber components. Even methanol alcohol, which is used in Alcohol Evaporators and Injectors, should not be poured into air lines. Fluids poured into the system wash lubricants out of valves, collect in brake chambers and valves and can cause malfunction. Loss of lubricant can affect valve operating characteristics, accelerate wear and cause premature replacement.
3. Do not park a vehicle outside after thawing its air system indoors. Condensation will form in the system and freeze again. Place the vehicle in operation when it is removed to the outdoors.

### **Supporting Air and Electrical Lines**

Make certain tie wraps are replaced and support brackets are re-assembled if removed during routine maintenance. These items prevent the weight of ice and snow accumulations from breaking or disconnecting air lines and wires.

#### **Automatic Drain Valves (System without Air Dryer)**

As we stated last year, routine reservoir draining is the most basic step (although not completely effective) in reducing the possibility of freeze-up. While automatic drain valves relieve the operator of draining reservoirs on a daily basis, these valves **MUST** be routinely checked for proper operation. Don't overlook them until they fail and a road call is required.

## Application Matrix for Bendix® 360cc Single Cylinder and 720cc Twin Cylinder Compressors for International Maxxforce™ Big Bore Engines

This useful Compressor Application Guide is a simple point system using vehicle configuration and vocation options to help calculate the Bendix® compressor right for your vehicle. Review items 1 – 13, fill in the applicable points on each line, then refer to the application grid on the next page for the Bendix compressor selections that can meet your vehicle's intended use. When completing the worksheet, if a particular entry is not valid for your application, enter zero on that line. See the examples of how to use this calculator at the end of the next page.

Vehicle Configuration		Points
1. Vehicle is equipped with bulk offloading or central tire inflation		(See Note 1)
2. For every axle (tractor & trailer – including lifts):	Add 1.0 point/axle ▶	
3. For each non-steerable lift axle (additional points):	Add 1.0 point/axle ▶	
4. For each steerable lift axle (additional points):	Add 0.5 points/axle ▶	
5. Tractor and/or trailer is equipped with air suspension	Add 0.5 points ▶	

Vocation Options (Select the description that best fits)		
6. Vehicle is used as a city transit bus		(See Note 1)
7. Vehicle is used for pickup & delivery	a) Non-fuel hauler: add 0.5 points ▶	
	b) Fuel hauler: add 1.0 point ▶	
8. Vehicle is used for residential refuse		
	• Vehicle with a work brake	Add 4.5 points ▶
	• Vehicle without a work brake	Add 7.5 points ▶
9. Vehicle is used for rural or commercial refuse		Add 3.5 points ▶
10. Vehicle is used as a yard or terminal jockey		Add 7.5 points ▶
11. Vehicle is a dump truck, a concrete mixer, or is used in logging or construction		Add 2.0 points ▶
12. Vehicle is a fire truck ("Fast Fill" system) (See Note 2)		Add 6.0 points ▶
13. Vehicle is used for line haul		Add 0.0 points ▶











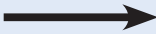









**Total Score**

(Add lines 1 – 13 and use that sum on page two of this guide)

*Note 1: Vehicles equipped with either bulk offloading, central tire inflation or used in City Transit bus applications are required to use a 720cc compressor. No points need to be calculated. Refer to next page for proper compressor selection.*

*Note 2: It is recommended that a 720cc compressor be used on all Fire Truck and Aircraft Rescue applications to reduce the complexity of the "Fast Fill" system.*

Appendix E

Compressor Application		Increasing Performance 		
		Point Total	360cc Single	720cc Dual
	School Bus / RV / Air over Hydraulic	any	✓	
	City Transit Bus / Highway Travel Coach / Express Route Coach	any		✓
	School Bus Rural Route (No Auto Brake)	any	✓	
	School Bus City Route (No Auto Brake)	any	✓	
	Pick-up & Delivery	2.5 - 9	✓	
		9.5 - 13		✓
	Line Haul	3 - 6	✓	
		6.5 - 9	✓	
		9.5 - 13		✓
	Rural or Commercial Refuse	6.5 - 9	✓	
	Rural or Commercial Refuse / Yard or Terminal Jockey	9.5 - 13		✓
	Residential Refuse (with Work Brake)	6.5 - 9	✓	
	Residential Refuse (no Work Brake)	9.5 - 13		✓
	Concrete Mixer / Dump Truck / Off-Highway / Construction / Logger	4 - 9	✓	
		9.5 - 13		✓
	Fire Trucks	6.5 - 9	✓	
		9.5 - 13		✓
	Bulk Off-loader	any		✓
	Central Tire Inflation	any		✓

Note: This compressor application matrix offers directional information when sizing a Bendix compressor for the applicable vehicle vocation. Testing should still be performed on the specific application to verify that the compressor remains within the 25% maximum allowable duty cycle. This application matrix assumes that all compressor installations use an air induction system that is naturally aspirated. The “Compressor Installation & Application Review” form explains the methods used to measure the vehicle’s duty cycle.

Compressor Selections	Point Totals																
	2.5	3	4	5	6	6.5	7	8	9	9.5	10	11	12	13	14	15	16 or above
Bendix® 360cc compressor	■	■	■	■	■	■	■	■	■								
Bendix® 720cc compressor										■	■	■	■	■	■	■	■
Points	2.5	3	4	5	6	6.5	7	8	9	9.5	10	11	12	13	14	15	16 or above

Certification to all applicable vehicle regulations is the sole responsibility of the vehicle manufacturer.

The application chart is for reference only. If your truck/tractor does not fall into these guidelines, please contact the Bendix Compressor Engineering or Technical Services team at 1-800-AIR-BRAKE.

## Appendix E

### Example #1: Typical Line Haul Application

#### Vehicle Configuration

1. Not Applicable
2. Total number of all axles = 3 points
3. Total number of non-steerable lift axles = 0 points
4. Total number of steerable lift axles = 0 points
5. Tractor is equipped with air suspension = .5 point

#### Vocation Options

- 6, 7, 8, 9, 10, 11, 12 (Not Applicable) = 0 points

**Total [ 3 + 0.5 = 3.5 points ]**

Selection: Bendix® 360cc Air Compressors



A typical single axle, line haul vehicle:

- Air suspension
- Three (3) axles total

### Example #2: Line Haul Pulling Single Axle Double

#### Vehicle Configuration

1. Not Applicable
2. Total number of all axles = 5 points
3. Total number of non-steerable lift axles = 0 points
4. Total number of steerable lift axles = 0 points
5. Tractor is equipped with air suspension = .5 point

#### Vocation Options

- 6, 7, 8, 9, 10, 11, 12 (Not Applicable) = 0 points

**Total [ 5 + 0.5 = 5.5 points ]**

Selection: Bendix® 360cc Air Compressors



A 4x2 line haul vehicle pulling:

- (2) single axle trailers
- (1) single axle dolly
- Tractor air suspension
- Five (5) axles total

### Example #3: Bulk Gravel Hauler

#### Vehicle Configuration

1. Not Applicable
2. Total number of all axles = 7 points
3. Total number of non-steerable lift axles = 2 points
4. Total number of steerable lift axles = 0 points
5. Tractor is equipped with air suspension = .5 point

#### Vocation Options

- 6, 7, 8, 9, 10, 12, 13 (Not Applicable) = 0 points  
 11 (Vehicle is used as a dump truck/construction) = 2 points

**Total [ 7 + 2 + 0.5 + 2 = 11.5 points ]**

Selection: Bendix® 720cc Air Compressors



A bulk gravel hauling vehicle:

- Two (2) non-steerable lift axles
- Truck equipped with air suspension
- Seven (7) axles total

### Example #4: Fuel Hauler (Not Equipped with Bulk Offloading)

#### Vehicle Configuration

1. Not Applicable
2. Total number of all axles = 7 points
3. Total number of non-steerable lift axles = 1 point
4. Total number of steerable lift axles = 0 points
5. Tractor is equipped with air suspension = .5 points

#### Vocation Options

- 6 (Vehicle is used as a fuel hauler) = 1 point  
 7, 8, 9, 10, 11, 12, 13 (Not Applicable) = 0 points

**Total [ 7 + 1 + 0.5 + 1 = 9.5 points ]**

Selection choices include: Bendix® BA-922® Air Compressor



A fuel delivery vehicle:

- Air suspension
- One (1) non-steerable lift axle
- Seven (7) axles total

